

Errata

Title & Document Type: 3588A Spectrum Analyzer Getting Started Guide

Manual Part Number: 03588-90005

Revision Date: March 1, 1990

HP References in this Manual

This manual may contain references to HP or Hewlett-Packard. Please note that Hewlett-Packard's former test and measurement, semiconductor products and chemical analysis businesses are now part of Agilent Technologies. We have made no changes to this manual copy. The HP XXXX referred to in this document is now the Agilent XXXX. For example, model number HP8648A is now model number Agilent 8648A.

About this Manual

We've added this manual to the Agilent website in an effort to help you support your product. This manual provides the best information we could find. It may be incomplete or contain dated information, and the scan quality may not be ideal. If we find a better copy in the future, we will add it to the Agilent website.

Support for Your Product

Agilent no longer sells or supports this product. You will find any other available product information on the Agilent Test & Measurement website:

www.tm.agilent.com

Search for the model number of this product, and the resulting product page will guide you to any available information. Our service centers may be able to perform calibration if no repair parts are needed, but no other support from Agilent is available.

HP 3588A
Getting Started Guide

Hewlett-Packard
8600 Soper Hill Road
Everett, Washington 98205-1298

Printed in U.S.A

HP 3588A Getting Started Guide

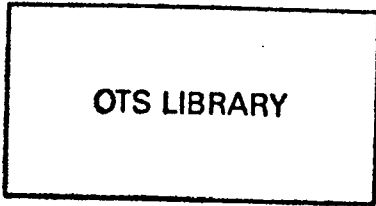

HP Part Number 03588-90005
Microfiche Part Number 03588-90205
Printed in U.S.A.

Print Date: March 1990

©Hewlett-Packard Company, 1990. All rights reserved.
8600 Soper Hill Road, Everett, WA 98205-1298

OTS LIBRARY



2400011467



SAFETY SUMMARY

The following general safety precautions must be observed during all phases of operation, service, and repair of this instrument. Failure to comply with these precautions or with specific warnings elsewhere in this manual violates safety standards of design, manufacture, and intended use of the instrument. Hewlett-Packard Company assumes no liability for the customer's failure to comply with these requirements. This is a Safety Class 1 instrument.

GROUND THE INSTRUMENT

To minimize shock hazard, the instrument chassis and cabinet must be connected to an electrical ground. The instrument is equipped with a three-conductor ac power cable. The power cable must either be plugged into an approved three-contact electrical outlet or used with a three-contact to two-contact adapter with the grounding wire (green) firmly connected to an electrical ground (safety ground) at the power outlet. The power jack and mating plug of the power cable meet International Electrotechnical Commission (IEC) safety standards.

DO NOT OPERATE IN AN EXPLOSIVE ATMOSPHERE

Do not operate the instrument in the presence of flammable gases or fumes. Operation of any electrical instrument in such an environment constitutes a definite safety hazard.

KEEP AWAY FROM LIVE CIRCUITS

Operating personnel must not remove instrument covers. Component replacement and internal adjustments must be made by qualified maintenance personnel. Do not replace components with power cable connected. Under certain conditions, dangerous voltages may exist even with the power cable removed. To avoid injuries, always disconnect power and discharge circuits before touching them.

DO NOT SERVICE OR ADJUST ALONE

Do not attempt internal service or adjustment unless another person, capable of rendering first aid and resuscitation, is present.

DO NOT SUBSTITUTE PARTS OR MODIFY INSTRUMENT

Because of the danger of introducing additional hazards, do not install substitute parts or perform any unauthorized modification to the instrument. Return the instrument to a Hewlett-Packard Sales and Service Office for service and repair to ensure the safety features are maintained.

DANGEROUS PROCEDURE WARNINGS

Warnings, such as the example below, precede potentially dangerous procedures throughout this manual. Instructions contained in the warnings must be followed.









Warning



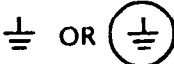

Dangerous voltages, capable of causing death, are present in this instrument. Use extreme caution when handling, testing, and adjusting.

SAFETY SYMBOLS

General Definitions of Safety Symbols Used On Equipment or In Manuals.

	Instruction manual symbol: the product will be marked with this symbol when it is necessary for the user to refer to the instruction manual in order to protect against damage to the instrument.
	Indicates dangerous voltage (terminals fed from the interior by voltage exceeding 1000 volts must be so marked.)
	Protective conductor terminal. For protection against electrical shock in case of a fault. Used with field wiring terminals to indicate the terminal which must be connected to ground before operating equipment.
	Low-noise or noiseless, clean ground (earth) terminal. Used for a signal common, as well as providing protection against electrical shock in case of a fault. A terminal marked with this symbol must be connected to ground in the manner described in the installation (operating) manual, and before operating the equipment.
	Frame or chassis terminal. A connection to the frame (chassis) of the equipment which normally includes all exposed metal structures.
	Alternating current (power line.)
	Direct current (power line.)
	Alternating or direct current (power line.)

Warning  The **WARNING** sign denotes a hazard. It calls attention to a procedure, practice, condition or the like, which if not correctly performed or adhered to, could result in injury or death to personnel.

Caution  The **CAUTION** sign denotes a hazard. It calls attention to an operating procedure, practice, condition or the like, which, if not correctly performed or adhered to, could result in damage to or destruction of part or all of the product.

Note  The **NOTE** sign denotes important information. It calls attention to procedure, practice, condition or the like, which is essential to highlight.

Table of Contents

PART I - The Basics

Chapter 1: Before You Begin

About the Analyzer	1-1
How to Use this Book	1-3
If You've Used a Spectrum Analyzer Before...	1-3
If You Haven't Used a Spectrum Analyzer Before...	1-3
Softkeys and Hardkeys	1-4
The Knob	1-4
Where to find Additional Information	1-5
Using the [Help] key	1-5
The Operating Manual	1-5
Other Information	1-5

Chapter 2: Your First Measurement

Task Overview	2-1
Task Setup	2-2
The Task	2-3

Chapter 3: Spectrum Analyzer Basics

Time Domain versus Frequency Domain	3-2
Linear versus Logarithmic Amplitude Axis	3-3
The Frequency Span	3-4
Local Oscillator Feedthrough	3-5
Measurement Speed, Amplitude Accuracy, and Frequency Resolution	3-6
Measuring Frequency Response	3-7
Spectrum Analyzers and Radio Receivers	3-8

PART II - Typical Measurements

Chapter 4: Characterizing a Signal Source

Task Overview	4-1
Task Setup	4-2
The Task	4-3

Chapter 5: Making Scalar Network Measurements

Task Overview	5-1
Task Setup	5-2
The Task	5-3

PART III - Beyond the Basics

Chapter 6: Limit Testing

Introduction 6-1

Task 1: Building an Arbitrary Limit 6-2

 Task Overview 6-2

 What you will do: 6-2

 Task Setup 6-3

 The Task 6-4

Task 2: Building a Limit from a Trace 6-8

 Task Overview 6-8

 Task Setup 6-9

 The Task 6-10

Chapter 7: Using Keystroke Recording to Generate an HP Instrument BASIC Program

Introduction 7-1

Task Overview 7-2

 What you will need: 7-2

 What you will do: 7-2

Task Setup 7-3

The Task 7-4

Chapter 8: Plotting and Printing Measurement Results

Introduction 8-1

Task 1: Preparing to Plot or Print 8-2

Task 2: Plotting or Printing 8-3

Chapter 9: Saving, Recalling, and Copying Files

Introduction 9-1

Overview 9-1

Selecting a Disk 9-1

Disk Specifier Prefix and Filenames 9-2

Data Registers 9-2

Typical Save and Recall Tasks 9-3

Task 1: Selecting the Default Disk 9-4

Task 2: Formatting a Blank Disk 9-5

Task 3: Saving a Trace 9-7

Task 4: Recalling a Trace 9-9

Task 5: Copying a Disk 9-10

Task 6: Copying a file 9-13



PART I
The Basics



Chapter 1

Before You Begin

Before You Begin

Please take a moment to read this chapter. Then go to chapter 2 to get comfortable with your new analyzer.

About the Analyzer

The Hewlett-Packard 3588A is a swept-tuned spectrum analyzer with a frequency range of 10 Hz to 150 MHz. As such, the instrument is a general-purpose design tool for measurement and evaluation of many electronic devices. In addition, a built-in source (tracking generator) lets you perform scalar network analysis for filters, amplifiers, and other devices. You can also operate the analyzer remotely, via the HP-IB, to make automated measurements—a feature that's particularly useful for repetitive tasks (such as those encountered in production-line testing).

The HP 3588A offers two measurement types—*Swept Spectrum* and *Narrow Band Zoom*. Both provide excellent resolution and operate at speeds far greater than conventional analyzers. Swept spectrum measurements provide the performance and features found in traditional Hewlett-Packard swept-tuned analyzers, but incorporate very sharp digital IF filters to provide improved frequency resolution (down to 1.14 Hz). For narrow band zoom measurements, the analyzer uses an implementation of the Fast Fourier Transform to provide faster measurements with even greater resolving power.

Faster measurements are possible with swept spectrum measurements since the analyzer uses digital IF filters. With selectivity nearly twice that of analog filters, digital filters offer faster measurements while still resolving low-level carrier sidebands. Additionally, the inherent predictability of digital filters permits the analyzer to sweep even faster, using a built-in correction algorithm. This provides increased measurement speed (up to four times faster than conventional swept-tuned analyzers for comparable measurements), with no additional amplitude error or resolution loss.

Narrow Band Zoom provides the fastest spectrum measurements (more than thirty times faster than swept-tuned analyzers for comparable measurements), with resolution performance unequalled by traditional technologies. Narrow Band Zoom can be used for spans of 40 kHz and less, and is ideal for narrowband analysis of close-in sidebands.

How is the HP 3588A Different than Previous Hewlett-Packard Swept-Tuned Analyzers?

For spans larger than 40 kHz, the HP 3588A functions exclusively as a traditional swept-tuned analyzer (but faster than previous analyzers). For spans smaller than 40 kHz, you have the choice of making swept spectrum measurements (with resolution down to nearly 1 Hz) or narrow band zoom measurements (with resolution down to about 3 mHz—yes, that's *millihertz*).

Narrow Band Zoom uses a Fast Fourier Transform (FFT) rather than a sweeping local oscillator to convert input data from the time domain to the frequency domain. The distinction between these two technologies is not important right now. The only important thing to know is that a combined swept-tuned/FFT analyzer is an analyzer with both wide frequency range and excellent frequency resolution/amplitude accuracy for small spans. For more detailed information about these two measurement types, see the *HP 3588A Operating Manual*.

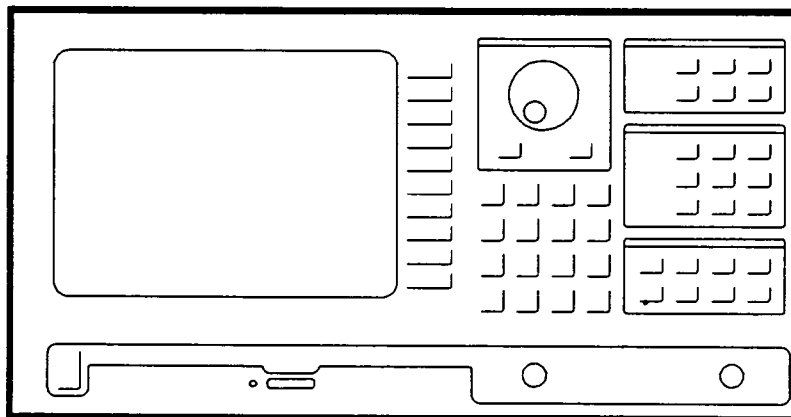

HP 3588A Spectrum Analyzer

How to Use this Book

If You've Used a Spectrum Analyzer Before...

If you've used a spectrum analyzer before, you should have no trouble making measurements with the HP 3588A. This instrument has many of the same features found in other Hewlett-Packard spectrum analyzers—and some additional features as well.

To get comfortable with the analyzer, proceed directly to *Part II: Typical Measurements*. Here you'll find two measurements tasks—source characterization and device characterization—that should be very familiar if you've already used a spectrum analyzer.

To learn about additional analyzer features, spend some time with *Part III: Beyond the Basics*. Here you'll find an introduction to limit testing and keystroke recording with HP Instrument BASIC—two features that make it easy to build automated measurement routines. You will also learn about plotting/printing measurement results and saving, recalling, and copying measurement data. Where appropriate, each chapter contains sample measurements tasks to help you get comfortable with these features.

If You Haven't Used a Spectrum Analyzer Before...

If you haven't used a spectrum analyzer before, you should carefully read *Part I: The Basics*. This contains essential background material to help you understand and use the HP 3588A. In particular, be sure to review chapter 3, "Measurement Basics."

Afterwards, proceed to *Part II: Typical Measurements*. The two sample measurements here are representative of many common measurements made with spectrum analyzers. And since each task introduces the analyzer's features in a sequential, easy-to-understand fashion, you'll soon have the skills necessary to use the analyzer with total confidence.

Keep in mind that simply looking over the measurement tasks is not enough to really learn how to use the analyzer. If at all possible, gather the necessary equipment (outlined at the beginning of each task), set things up, and step through each measurement task.

To learn about additional analyzer features, spend some time with *Part III: Beyond the Basics*. Here you'll find an introduction to limit testing and keystroke recording with HP Instrument BASIC—two features that make it easy to build automated measurement routines. You will also learn about plotting/printing measurement results and saving, recalling, and copying measurement data. Where appropriate, each chapter contains sample measurements tasks to help you get comfortable with these features.

Softkeys and Hardkeys

Before you use this book, it's important to understand the difference between hardkeys and softkeys.

Hardkeys are front-panel buttons whose functions are always the same. Hardkeys have a label printed directly on the key itself. Throughout this book, they are printed like this: [**Hardkey**].

Softkeys are keys whose functions change with the analyzer's current menu selection. A softkey's function is indicated by a video label to the left of the key (on the edge of the analyzer's screen). Throughout this book, softkeys are printed like this: [**SOFTKEY**].

Some softkeys toggle through different settings. Toggle softkeys have a highlighted word in their label that changes with each press of the softkey. Throughout this book, toggle softkeys are depicted as they *appear after you make the keypress*. For example, "toggle to [**FREQ CNTR ONOFF**]" means to press [**FREQ CNTR ON/OFF**] until the word **ON** is highlighted.

The Knob

The *knob* is an RPG (rotary pulse generator) that controls two things—movement of the on-screen marker and continuous entry of numeric values. Usually, the knob simply moves the marker. But after pressing a softkey that requires a numeric entry, the knob becomes dedicated to numeric entry. Turn the knob to the right and the analyzer steps through larger numeric entries. Turn to the left and the analyzer steps through increasingly smaller entries.

When numeric entry is active, an entry box appears at the top of the screen with the currently-selected numeric value. This box remains on screen for several seconds to give you a chance to enter a numeric value. After using the knob (or, alternatively, the numeric entry keypad) this box soon disappears and the knob returns to marker movement.

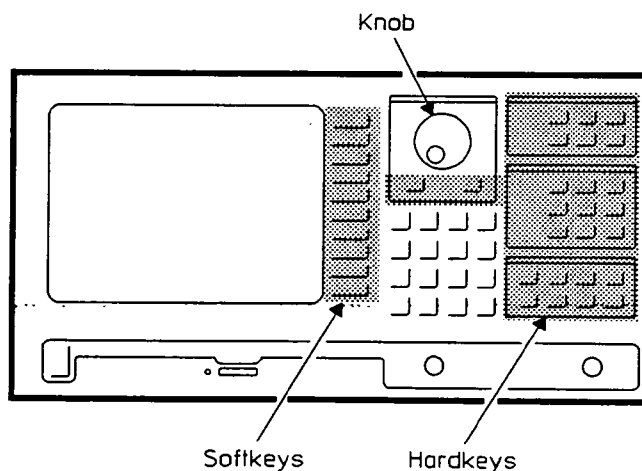

Where to find Additional Information

Using the [Help] key

The [Help] key on the analyzer's front panel provides fast, easy-to-read information about specific instrument controls and features. Using [Help] is particularly convenient when you need assistance and you don't have the analyzer's *Getting Started Guide* or *Operating Manual* near at hand.

The [Help] key is also a good way to learn about the analyzer (or to refresh your memory if you don't use the analyzer very often). The help facility also has an index that lets you request information by key name or by topic.

The Operating Manual

To learn more about the analyzer's controls and features, refer to the *HP 3588A Operating Manual*. The operating manual is a comprehensive reference that offers in-depth discussion of each analyzer control and feature (and introductory tours of both front and rear panels). You will also find in-depth discussion of specialized measurement techniques—for example, ways to increase the dynamic range of the analyzer. There are also easy-to-follow tasks that show how to use certain features to their best advantage.

Other Information

- For specifications, installation instructions, and performance tests, see the *HP 3588A Performance Test Guide*.
- For service information, see the *HP 3588A Service Manual*.
- To help you operate the analyzer remotely via HP-IB, see the *HP 3588A HP-IB Programming Reference*.
- To learn more about HP Instrument BASIC (a subset of the HP BASIC programming language), see *Using HP Instrument BASIC with the HP 3588A Spectrum Analyzer*.

Additionally, you will find applications information in numerous Hewlett-Packard application notes. These are available from your local HP Sales and Service Office. In particular, you might want to request some of the following application notes:

- AN 150 series (several application notes—some recently updated—that cover many topics dealing with spectrum analysis).
- AN 246-1: *Optimizing the Dynamic Range of the HP 3585A Spectrum Analyzer*.
- AN 378-1: *Harmonic Distortion Measurements*.



Chapter 2

Your First Measurement

Your First Measurement

If you haven't used the analyzer before, take a few minutes to make this first measurement.

Task Overview

This task shows you how to look at a test signal, measure its frequency, and then find the level of the second harmonic.

What you will need:

- One connecting cable, BNC male to BNC male—cable length must be 48 inches (122 cm) or longer.
- RF Generator (not required).

What you will do:

- Look at a 10 MHz test signal.
- Measure the frequency and amplitude of the fundamental.
- Look for the second harmonic of the fundamental frequency, and measure its amplitude.
- Create a title for the displayed trace.

Task Setup

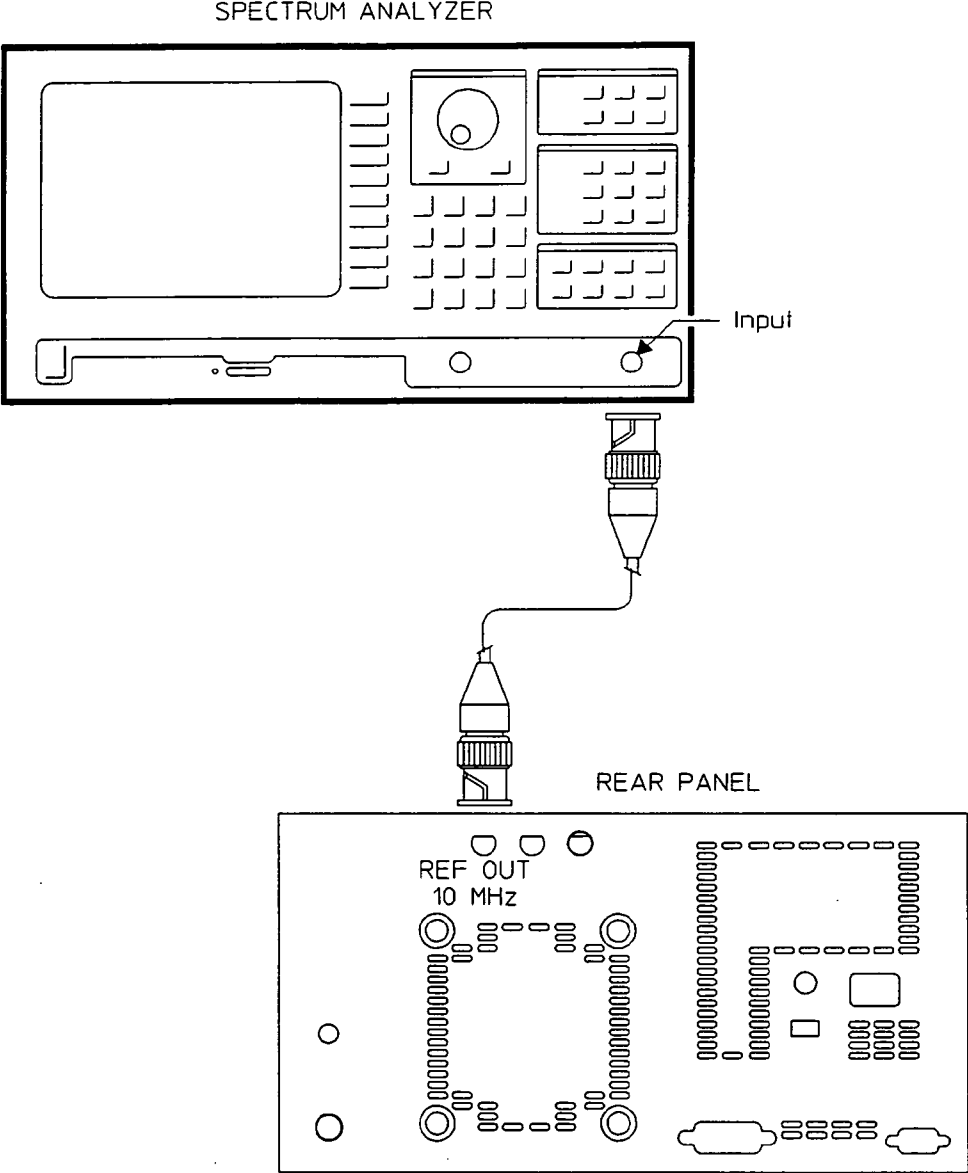

The Task

1. If you've already turned on the analyzer, press [**Preset**].

If the analyzer is off, turn it on and wait until it warms up and calibrates. Then press [**Preset**].

2. Using a BNC cable, connect the analyzer's 10 MHz reference signal (the REF OUT connector on the rear panel) to the analyzer's input.

Alternatively, you can connect an RF generator to the analyzer's input.

3. Now look at the analyzer's screen. You should see the fundamental and at least one harmonic.

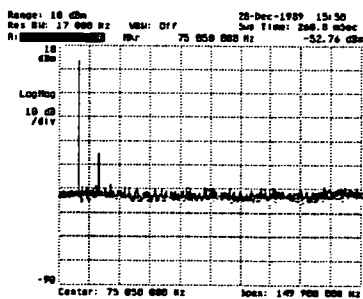

Pressing [**Preset**] returns most of the analyzer settings to their default positions.

For this task, we'll use the analyzer's rear-panel reference output for our test signal. This is a 10 MHz signal at about 3 dBm, with a 50Ω impedance.

If you have an RF generator, you can use it for this task instead of the analyzer's own 10 MHz reference. You can set the output to 3 dBm.

If you're using an RF generator with a 75Ω output, press [**Range/Input**]. Then press [**75 OHMS**]. You must also place a 75-to-50Ω converter (a 25Ω series resistor) between the RF generator and the analyzer's input.

You can also measure devices with output impedances other than 50Ω or 75Ω if you use the analyzer's 1 MΩ input setting. We'll discuss this further in chapter 4.

The default frequency span is 100 kHz to 150 MHz. The 10 MHz test signal appears to the left of the analyzer's display.

Notice how the display changes several times each second. Each display represents one frequency sweep of the analyzer's local oscillator.

Your First Measurement
The Task

4. Press [Avg/Pk Hld]

[VIDEO AVERAGE].

This turns on video averaging. When averaging is on, the analyzer combines the results of the most recent frequency sweep to the accumulated results of previous sweeps. Once averaging is on, it continues until you turn off averaging. It does not stop automatically after a certain number of averages.

Video averaging does not actually lower the noise level. However, it does *smooth* the noise floor and, in some cases, can reveal low-level components that would be obscured by the more uneven noise floor of an unaveraged measurement.

We'll explain video averaging further in chapter 4, "Source Characterization."

5. Press [Meas Restart].

This discards the accumulated averages and restarts the averaging process.

6. Press [Marker]

[MKR --> PEAK].

This moves the marker to the largest frequency component on the display—in this case, the fundamental. The marker frequency (shown at the top of the screen) indicates that the fundamental is about 10 MHz.

Note the frequency value indicated by the marker readout.

For large frequency spans, the marker's frequency resolution is rather coarse (the analyzer's screen always shows 401 points, regardless of the span). Thus the marker may not indicate the exact frequency of the RF generator. In the example here, the marker readout is about 9.84 MHz.

7. Press [Marker Fctn].

This turns on the frequency counter. This activates a frequency counter that provides an accurate readout at the current marker position. The counter is updated after each frequency sweep.

Toggle to [FREQ CNTR ON/OFF].

Notice how the counter gives a more accurate frequency indication for the marker position—in this case, the test signal is really at 10 MHz, not 9.84 MHz.

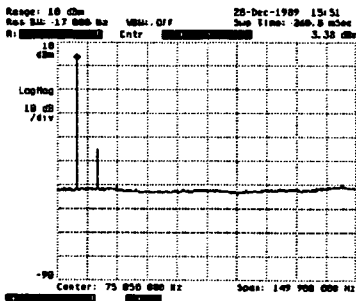

8. Toggle to [FREQ CNTR ON/OFF].

9. Note the amplitude value indicated by the marker readout.

10. Press [Marker]

[NXT RIGHT PEAK] until the marker moves to 20 MHz.

11. Note the amplitude value indicated by the marker readout.

12. Press [Trace Data]

[TRACE TITLE].

Then use the knob, the numeric-entry keys, and the alpha-shifted hardkeys to enter a name for the stored trace.

Afterwards, press [ENTER].

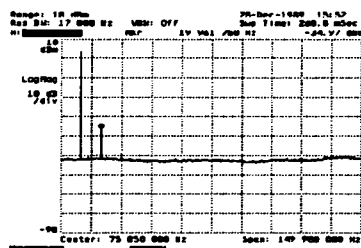

This turns off the counter.

This shows the absolute amplitude of the fundamental. In this case, the y-axis marker value indicates about 3 dBm.

This moves the marker to the second harmonic.

Alternatively, you could use turn the knob to move the marker to the second harmonic. The knob is also useful when entering numeric values, as we'll discover in chapter 4.

This value is about 35 dBm. Since the fundamental is about 3 dBm, the second harmonic is about 40 dB below the fundamental.

In the example here, we selected "10 MHz REF" as the trace title.

When the analyzer prompts you for a name—a trace title, for example—it automatically switches to alpha entry mode.

In alpha entry mode, the analyzer shifts certain hardkeys to alpha entry keys (note the alpha characters engraved on the front panel below these hardkeys). You can also specify uppercase or lowercase letters, using the [UPPERCASE LOWERCASE] softkey.

If you make a mistake, you can use the appropriate edit softkeys to fix the title. You can also use the knob to help you edit.

To use the default trace title, simply press [Trace Data], [TRACE TITLE], and [CLEAR ENTRY]. Then press [ENTER].



Chapter 3

Spectrum Analyzer Basics

Spectrum Analyzer Basics

The following chapter is designed for people who haven't used a spectrum analyzer before. If you've already used a spectrum analyzer (and feel comfortable with the basics of spectrum analysis), proceed directly to PART II of this book.

Time Domain versus Frequency Domain

If you haven't used a spectrum analyzer before, it's important to understand the difference between time-domain displays and frequency-domain displays.

Time-domain displays show a parameter (usually amplitude) versus *time*. This is the traditional way of looking at a signal. Oscilloscopes display signals in the time domain.

Frequency-domain displays show a parameter (again, usually amplitude) versus *frequency*. A spectrum analyzer takes an analog input signal—a time-domain signal—and converts it to the frequency domain (the specific process used to make this conversion is not important right now). The resulting spectrum measurement shows the energy of each frequency component at each point along the frequency spectrum.

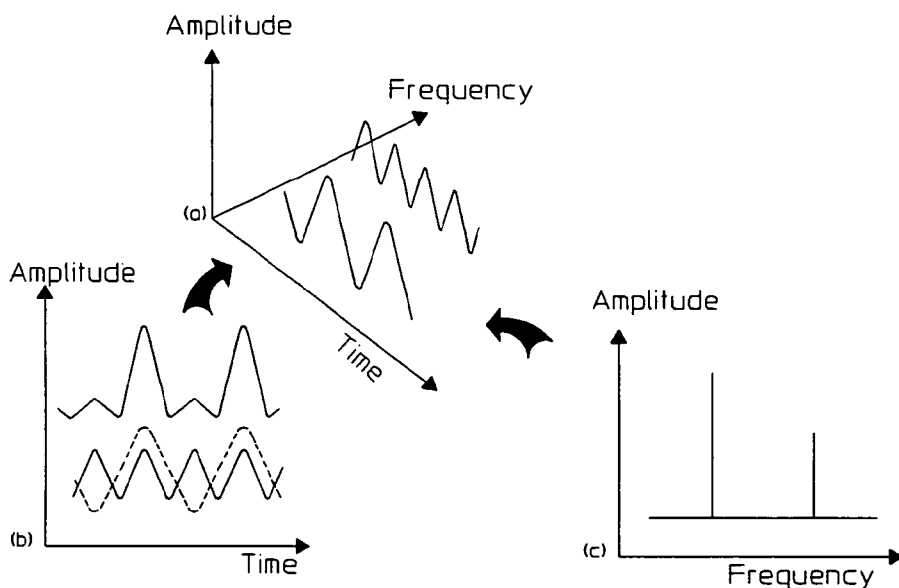

The Relationship between Time and Frequency Domains

Now look at the nearby illustration. Notice the difference between the time-domain and frequency-domain displays of the same input signal.

Many signals not visible in the time domain (such as noise and distortion products) are clearly visible in the frequency domain. Because spectrum displays show frequency components distributed along the frequency axis, it's possible to view many different signals at the same time. This is why the spectrum analyzer is such a useful tool for looking at complex signals—it lets you easily measure (and compare) the frequency and amplitude of individual components.

Linear versus Logarithmic Amplitude Axis

Time-domain displays usually have a linear x-axis and a linear y-axis (think of an oscilloscope). However, frequency-domain displays usually use a *logarithmic* y-axis (the amplitude axis) to show both small signals and large signals.

Let's look at the spectrum of a sine wave. Because the amplitude of any harmonic is small relative to the fundamental frequency, it's nearly impossible to view a harmonic on the same display as the fundamental unless the y-axis scale is logarithmic. That's why most measurements made with spectrum analyzers use a logarithmic amplitude scale—a scale based on decibels. And since the dB scale is by definition logarithmic, there's no need to use logarithmically-spaced graticule lines.

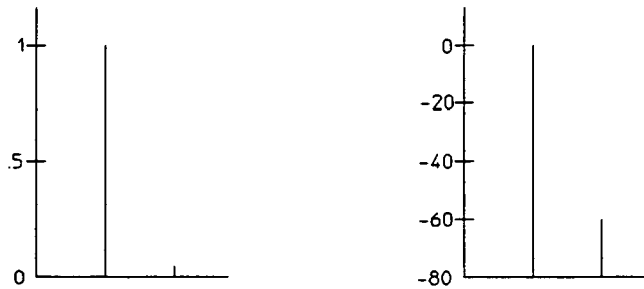

Small Signals can be Measured with a Logarithmic Amplitude Scale

The Frequency Span

You can vary the size and the center frequency of the measurement span to best suit your particular needs. The HP 3588A always presents data with a 401-point resolution, regardless of the span you've selected.

Full-span measurements let you view the entire frequency spectrum on one display. With the HP 3588A, the spectrum will extend from 10 Hz to 150 MHz (information below 10 Hz can be displayed, but is not guaranteed to be accurate).

Alternatively, you may wish to view smaller slices of the frequency spectrum. You can select any number of different spans and position these spans where you want by specifying their start or center frequencies. This process of viewing smaller spans is sometimes called "zooming."

Local Oscillator Feedthrough

When viewing frequency spans that start at 0 Hz (or very close to 0 Hz), a spectral line is usually visible at the extreme left of the analyzer's display. This is the *local oscillator feedthrough*—sometimes called “zero response.” The energy measured here, in the first few display points, is not due to the input signal. Rather, it is energy measured from the analyzer's own local oscillator.

Local oscillator feedthrough is common to *all* swept-tuned analyzers. It is not specific to any particular analyzer. Local oscillator feedthrough diminishes as you view frequency spans that start significantly above 0 Hz. For more information, see the *HP 3588A Operating Manual*.

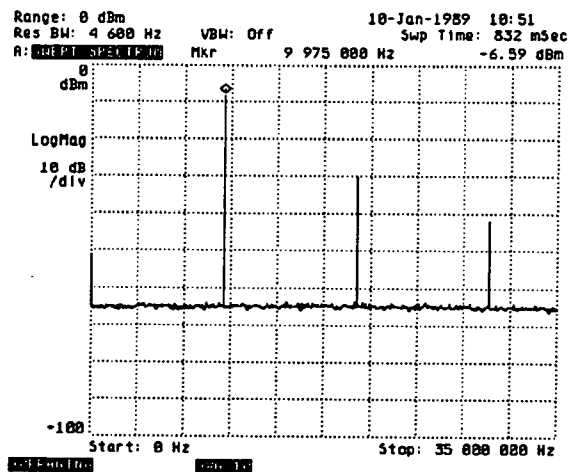

Typical Spectrum Analyzer Display, Showing L.O. Feedthrough at 0 Hz (extreme left)

Measurement Speed, Amplitude Accuracy, and Frequency Resolution

As you begin to use a spectrum analyzer, you will find that measurement speed, amplitude accuracy, and frequency resolution are all related. For smaller frequency spans, the analyzer needs more time to make a measurement. The analyzer also needs more time to make measurements with greater amplitude accuracy. And the same holds true for measurements that require the greatest frequency resolution. These relationships are common to *all* swept-tuned spectrum analyzers, not just the HP 3588A.

Although the HP 3588A is much faster than previous Hewlett-Packard spectrum analyzers, the relationship between measurement speed, amplitude accuracy, and frequency resolution is still important because it determines just how fast you can make a measurement. To learn more about all this, see the *HP 3588A Operating Manual*.

Measuring Frequency Response

Like many other swept-tuned spectrum analyzers, the HP 3588A has a built-in sinusoidal signal source (sometimes called a *tracking generator*). One type of measurement you can make using the analyzer's source is a swept frequency-response measurements. This is a good way to characterize the amplitude versus frequency response of filters, amplifiers, and other electronic devices. We'll show you how to do all these things in *Part II: Typical Measurements*.

Spectrum Analyzers and Radio Receivers

Understanding how a spectrum analyzer works is often easier if we compare a swept-tuned spectrum analyzer to a general-coverage communications radio receiver. Both devices, at the block level, are actually quite similar. Consider the following:

- The front-end of a swept-tuned spectrum analyzer and a communications radio receiver are nearly identical. Both are superheterodyne devices that use local oscillators and multiple mixing stages to convert the signals of interest down to intermediate frequencies, where fixed-tuned filters can more easily provide good frequency resolution. And like many communications radio receivers, swept-tuned spectrum analyzers use multiple conversion (several IF stages) to more easily reject image frequencies. Both devices can also vary the bandwidth of the final IF filter to control selectivity. In fact, it's only after the detector stage that the circuit diagrams for a typical spectrum analyzer and a radio receiver begin to look quite different.
- Both devices have variable local oscillators to examine frequencies of interest. In the spectrum analyzer, the local oscillator usually sweeps across a range of frequencies (this eventually translates to a visual sweep between the start and stop frequencies of the spectrum you're examining). In the radio receiver, the local oscillator can also be varied, but is set to a single frequency while listening to a particular broadcast station.
- Both devices use a detector after the final IF stage to recover the incoming signal. In a spectrum analyzer, the detected signal is converted to a dc value (representing its amplitude) and then sent to the display-driver circuitry—where you can view the signal on a CRT display. In a radio receiver, the detected signal is demodulated (to recover its original ac modulation) and then sent to an audio amplifier and then to headphones or a loudspeaker that you can use to monitor the signal.

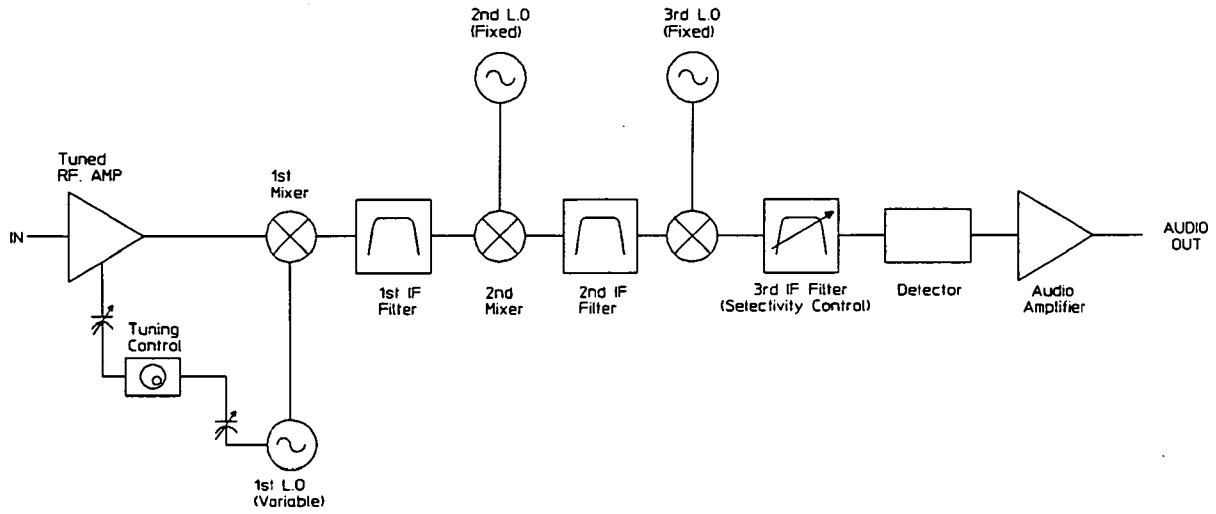

Typical Superheterodyne Communications Radio Receiver

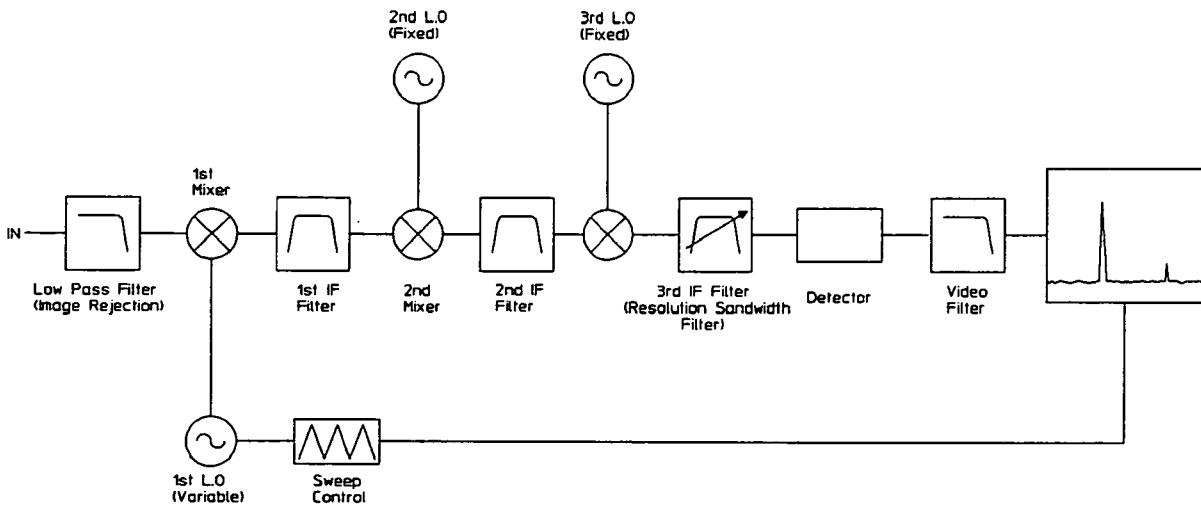

Typical Swept-tuned Spectrum Analyzer



PART II
Typical Measurements



Chapter 4

Characterizing a Signal Source

Characterizing a Signal Source

Task Overview

This chapter steps you through a series of measurements to characterize a signal source.

What you will need:

- A connecting cable (BNC male to BNC male).
- Appropriate converters or terminators, if your RF generator has an output impedance other than 50Ω .

What you will measure:

- Frequency and amplitude of the test signal.
- Relative amplitude of prominent harmonics (to calculate harmonic distortion).
- Powerline sidebands.
- Frequency drift.

What you will learn:

- Viewing a spectrum to reveal a fundamental frequency and its harmonics.
- Setting the proper input range.
- Selecting an appropriate scale.
- Using both the main marker and the offset marker.
- Using video averaging.
- Using the frequency counter to accurately set the center frequency.
- Using the Peak Hold function.

Task Setup

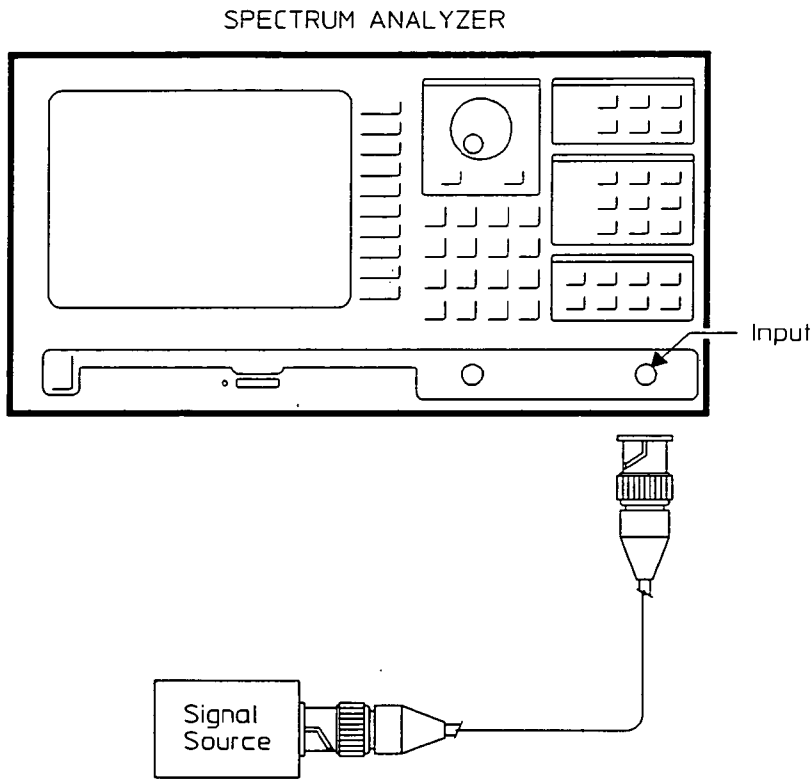

The Task

As you step through the following task, you may find that your measurement results differ slightly from those shown here. Keep in mind that the tasks are designed to help you learn about the analyzer—not to duplicate specific measurement results.

1. If you've already turned on the analyzer, press [**Preset**].

If the analyzer is off, turn it on and wait until it warms up and calibrates. Then press [**Preset**].

2. Connect the signal source to the analyzer's input.

If your source has an output impedance of 50Ω , proceed to Step 5.

3. If your signal source has a 75Ω output, press [**Range/Input**] and then press [**75 OHMS**].

4. If your signal source has a non-standard output impedance, connect an appropriate terminator across its output and use the analyzer's $1\text{ M}\Omega$ input setting.

5. Press [**Range/Input**].

Pressing [**Preset**] returns most of the analyzer settings to their default positions.

In the example here, we're using a 49 MHz crystal oscillator. You could also use an RF generator or frequency synthesizer as a signal source.

The default value for the analyzer's input is 50Ω , though you can also select a 75Ω or $1\text{ M}\Omega$ input impedance. Selecting the proper input impedance is important to ensure accurate amplitude measurements.

Make sure you connect a 75-to- 50Ω converter (a series 25Ω resistor) between the test signal and the analyzer's input.

Keep in mind that selecting the $1\text{ M}\Omega$ input impedance limits you to one input range. Also, the $1\text{ M}\Omega$ input is designed to measure frequencies up to 40 MHz (measurements made in excess of 40 MHz are not guaranteed to meet the analyzer's published specifications).

Notice how the "autorange" feature is on (this is the default position for autorange).

When autoranging is on, the analyzer continuously monitors the amplitude of the input signals and, if necessary, automatically changes the input range.

6. Press [Avg/Pk Hld]

[VIDEO AVERAGE].

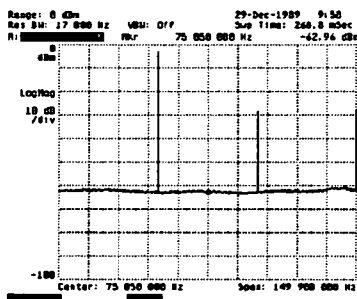

If the input signal increases enough to overload the current input range, the analyzer changes to a less-sensitive input range. If the input signal decreases enough to compromise the dynamic range of the current measurement, the analyzer changes to a more-sensitive input range.

When autoranging occurs, you'll see an "AUTORANGE IN PROGRESS" message at the top of the screen.

Because the 1 M Ω input impedance is limited to one input range, autoranging is inactive if you select the 1 M Ω input impedance.

This turns on video averaging. When averaging is on, the analyzer combines the results of the most recent frequency sweep to the accumulated results of previous sweeps. Once averaging is on, it continues until you turn off averaging. It does not stop automatically after a certain number of averages.

Video averaging does not actually lower the noise level. However, it does *smooth* the noise floor and, in some cases, can reveal low-level components that would be obscured by the more uneven noise floor of an unaveraged measurement.

Averaging in the HP 3588A is an exponential average. This means the number of averages you select determines the weighting of old data versus new data, not simply the total number of averages calculated. As you increase the number of averages, new data is weighted less. Exponential averaging is particularly useful for tracking data that changes over time.

To calculate the average, the analyzer uses this formula:

$$\text{next value} = \frac{1}{N} (\text{new value}) + \frac{N-1}{N} (\text{current value})$$

where N is a weighting factor (the number of averages you've specified).

With exponential averaging, it's important to set the number of averages carefully. If there are too few averages in the measurement, the averaging will not smooth out variances. But if there are too many averages, the analyzer may not track subtle changes occurring within the data.

For example, if you set N to 100, the new sweep data is weighted by $1/100$ and the current data by $99/100$. You can see that for this example, each successive sweep does not change the trace very much. If you change the input signal, the displayed trace will show these changes very slowly.

Now consider another example—setting N equal to 5. Here the new sweep data is weighted by $1/5$ and the current data by $4/5$. In this case, each sweep can make a considerable difference to the trace. If you change the input signal, the displayed trace will show these changes much more quickly.

To learn more about video averaging, see the *HP 3588A Operating Manual*.

Note how another averaged measurement begins.

The display should now look like this. You changed the vertical scaling from 10 to 8 dB per division.

If your signal source has a noisier or cleaner signal, you can specify a different vertical scaling that better suits your needs.

7. Press [Meas Restart].

8. Press [Scale]
[VERTICAL/DIV].

Using the numeric keypad,
enter 8 [dB].

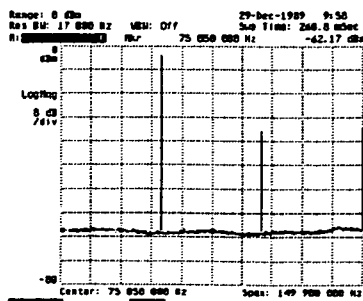

Characterizing a Signal Source

The Task

9. Press [AUTO SCALE].

10. Press [REFERENCE LEVEL].

Turn the knob to shift the entire display up or down.

11. Press [Marker]

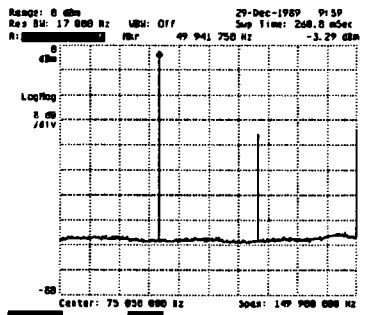

[MKR --> PEAK].



Autoscaling means the analyzer automatically selects an appropriate scale for the input signal.

Alternatively, you could have pressed [VERTICAL/DIV] and entered the original scaling—in this case, 10 dB per division.

See how easy it is to adjust the display to your liking?

You can also shift the display using the [] and [] hardkeys—these are the hardkeys labeled with an up-arrow and a down-arrow.

Alternatively, you can specify a particular reference level with the numeric keypad.

This moves the marker to the largest frequency component on the display—in this case, the fundamental.

The marker you are using is the *main marker* (sometimes simply called *the marker*). It is an absolute marker—that is, it indicates the absolute x-axis and y-axis coordinate. There's also an *offset marker*—but you'll learn about that in a few moments.

The analyzer says that the x-axis marker value is about 49 MHz. Remember—the analyzer's frequency resolution changes with the frequency span you've selected.

Though it's not important right now, you could narrow the analyzer's span (thereby getting better frequency resolution) to better approximate the signal's actual frequency.

Better yet, you could simply use the analyzer's frequency counter to make an accurate frequency measurement without selecting a smaller frequency span. You'll learn more about the frequency counter later in this task.

Characterizing a Signal Source

The Task

- Turn the knob until the marker is at the second harmonic.

- Note the frequency value indicated by the offset marker's x-axis position.

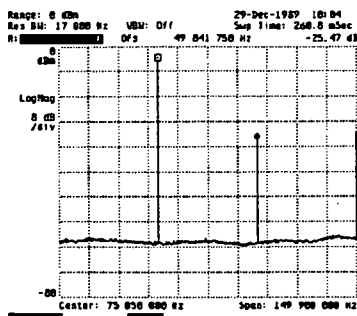

- Note the amplitude value indicated by the offset marker's y-axis position.

- To calculate harmonic distortion, make a note of the relative amplitudes of the prominent harmonics.

This moves the marker to the second harmonic.

You can also use the [NXT RIGHT PEAK] or [NXT LEFT PEAK] softkeys to move the marker.

This value (actually the offset from the fundamental) is about 49 MHz. Not surprising, since the second harmonic should be offset from the fundamental by the fundamental's frequency.

This value is about 25 dB, referenced to the fundamental frequency's amplitude. In other words, the second harmonic is about 25 dB below the fundamental.

One way to calculate THD is to write an HP Instrument BASIC program that makes the appropriate calculations.

To calculate THD, each harmonic must be converted to relative percentage of the fundamental. Use this formula:

$$\%(\text{THD}) = 10^{-4\text{B}/20} \times 100$$

Then, simply add together percentages for each harmonic to be included in the THD calculation.

In the example here, the harmonic distortion is about 11 percent.

19. Now toggle to [OFFSET ON/OFF].

20. Press [Marker]

[MKR --> PEAK].

21. Press [MKR --> CTR FREQ].

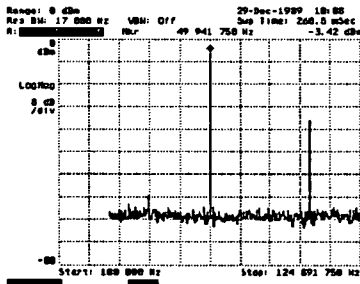

22. Press [Freq]

[SPAN].

Turn the knob until you select the 200 kHz span.

Alternatively, you could use this formula:

$$\text{THD (\%)} = 100 \times \frac{\sqrt{(A_2)^2 + (A_3)^2 + \dots + (A_n)^2}}{A_1}$$

where A_1 = fundamental amplitude (volt)

where A_2 = second harmonic amplitude (volts)

where A_3 = third harmonic amplitude (volts)

This turns off the offset marker.

This again moves the marker to the fundamental.

This places the 49 MHz signal at the center of the analyzer's screen.

Notice how the sweep span is limited. The analyzer displays a limited span any time the combination of center frequency and frequency span exceeds the upper or lower frequency limits of the analyzer.

In a moment, we'll use the analyzer's narrow band zoom measurement type to examine the 49 MHz component and look for powerline sidebands.

Before changing to narrow band zoom, it's important to accurately place the signal you want to examine at the center of the analyzer's screen. There are several ways to do this. One way is to use a much smaller frequency span while still making a swept spectrum measurement—the other is to use the analyzer's frequency counter. We'll show you how to do both.

If you don't locate the signal precisely at the center of the screen, it can be very difficult to find the signal once you've selected narrow band zoom—since narrow band zoom examines that small portion of the frequency spectrum (40 kHz or less) centered around the current center frequency value.

In some cases, you can simply Press [Freq], [CENTER], and use the numeric keypad to enter the known frequency of a signal you want to examine in narrow band zoom (in this example, 49 MHz). However, if the signal is more than 20 kHz away from the center frequency you specify, you won't be able to find it when you enter narrow band zoom.

This moves the marker to peak and then moves the peak to the center of the screen.

23. Press [Marker]

[MKR --> PEAK]

[MKR --> CTR FREQ]

24. There's another way to place a signal at the center of a frequency span.

In the next few steps, you'll use the analyzer's frequency counter to accurately place a signal at the center of a span.

25. Press [Freq]

[FULL SPAN].

This selects the analyzer's full span of 0 Hz to 150 MHz.

26. Press [Marker Fctn]

Then toggle to
[FREQ CNTR ON OFF]

This turns on the frequency counter. This activates a frequency counter that provides an accurate readout at the current marker position. The counter is updated after each frequency sweep.

27. Press [Marker]

[MKR --> PEAK]

[MKR --> CTR FREQ].

This moves the marker to the signal to the center of the screen.

When the frequency counter is on, the analyzer uses the *counter frequency*—not the marker position—to determine the center frequency.

28. Press [Meas Type]

[NARROW BAND ZOOM].

This selects narrow band zoom. Narrow band zoom is an implementation of the Fast Fourier Transform and allows fast, convenient examination of very narrow spans—a feature that makes it easy to look for powerline sidebands that may be present with the test signal.

Notice how averaging in narrow band zoom is similar to averaging when making swept spectrum measurements, but instead of combining frequency sweeps, the analyzer combines the results of successive FFT measurements.

29. Press

[Marker Fctn].

Then toggle to

[FREQ CNTR ON OFF].

This turns off the frequency counter.

The counter isn't needed any more, and turning it off speeds up your measurements.

30. Press [Scale]

[AUTOSCALE].

Some autoscaling may be necessary.

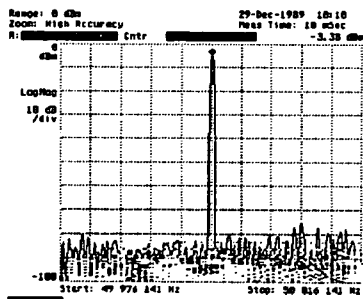

Characterizing a Signal Source
The Task

31. Press [Freq]

[SPAN].

Turn the knob until you select the 625 kHz span.

32. Press [Marker]

[ZERO OFFSET].

33. Press [Marker].

Then use

[NXT RIGHT PEAK] and

[NXT LEFT PEAK] to examine the powerline sidebands.

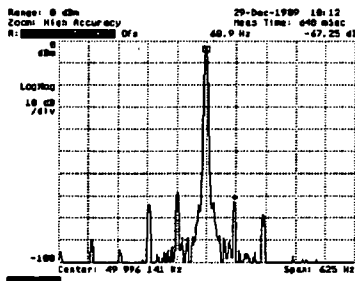

34. Press [Freq]

[SPAN].

Turn the knob until you select the 78.125 Hz span.

You can also use the numeric keypad to specify a 625 kHz span, or simply press [] repeatedly until you reach 625 Hz—but using the knob is much faster.

This narrows the frequency span to let us view any powerline sidebands that may be present.

This turns on the offset marker and zeroes it at the signal peak.

We'll use the offset marker to find the relative amplitude of powerline sidebands.

In this example, the 60 Hz sidebands are about 65 dB below the 49 MHz signal. The 120 Hz sidebands are about 75 dB below the signal.

In a moment, we'll look at the frequency drift of this test signal. But first, we must switch to a relatively narrow frequency span to provide the high resolution needed for this type of measurement.

35. Press [Avg/Pk Hld]

[PEAK HOLD].

36. Press [Marker]

[MKR --> PEAK]

[MKR --> CTR FREQ].

37. Press [ZERO OFFSET].

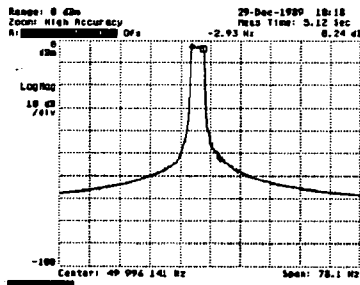

To measure frequency drift, we'll use the analyzer's peak hold feature.

As long as the peak hold function is active, the analyzer screen will show the maximum amplitude value recorded for each point in the display.

This again moves the signal to the center of the screen.

This anchors the offset marker at a known frequency so you can observe the amount of drift by simply moving the marker with the drifting signal.

Using the knob, move the main marker to measure the frequency drift relative to the offset marker.

If your test device does not have noticeable drift, you may need to turn it off for a while. Once the device has cooled off, you can turn it back on and observe the amount of drift during its warmup time.



Chapter 5

Making Scalar Network Measurements

Making Scalar Network Measurements

Task Overview

This chapter steps you through a typical scalar network measurement with the HP 3588A. In this example, we're going to characterize the performance of a 70 MHz bandpass filter. However, you can use a filter that has a different passband—the important thing is to understand the measurement task, not to duplicate the measurement shown here.

What you will need:

- RF Band-pass filter (preferably with 50 Ω input/output impedances).
- 50-to-75 Ω impedance converters (25 Ω series resistors) if your test device has 75 Ω inputs and outputs.
- Feedthrough terminators or impedance converters to match a test device with non-standard input/output impedances.
- Appropriate connecting cables.
- Barrel connector (to take the place of the device-under-test during the normalization procedure).

What you will measure:

- Amplitude versus frequency response of the test device.
- Resonant and passband frequencies.
- Insertion loss.

What you will learn:

- Making a scalar network measurement.
- Using the offset-to-marker span feature.
- Expanding the analyzer's vertical scale.
- Normalizing your results to cancel amplitude inaccuracies introduced by the test fixture (in this case, the cables used to connect the RF bandpass filter to the analyzer).
- Using the front/back format to display both Trace A and Trace B at the same time.

Task Setup

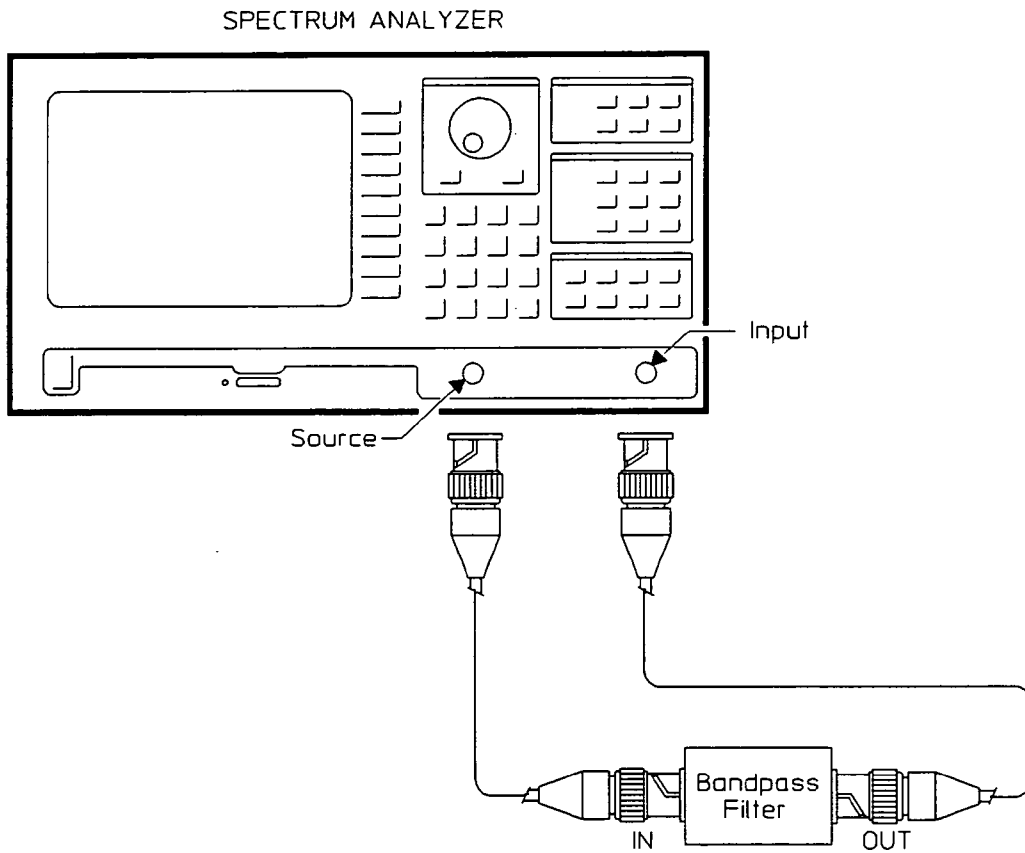

The Task

As you step through the following task, you may find that your measurement results differ slightly from those shown here. Keep in mind that the tasks are designed to help you learn about the analyzer—not to duplicate specific measurement results.

1. If you've already turned on the analyzer, press [**Preset**].

If the analyzer is off, turn it on and wait until it warms up and calibrates. Then press [**Preset**].

2. Connect the analyzer's source to the input of the RF filter.

Connect the output of the RF filter to the analyzer's input.

3. Press [**Range/Input**].

Then press [**50 OHMS**],

[**75 OHMS**],

or

[**1 MEGOHM**].

4. Toggle to [**AUTORANGE ON/OFF**].

Pressing [**Preset**] returns most of the analyzer settings to their default positions.

It's a good idea to use short cables of equal length. This minimizes any possible impedance mismatch.

Select the impedance that matches the output of your test device.

If your test device has a 50 Ω output, simply select the 50 Ω input (this is the default value).

If your test device has a 75 Ω output, select the 75 Ω input and attach a 75-to-50 Ω converter (a 25 Ω series resistor) between the test device and the analyzer's input connector.

If your test device has a non-standard output impedance, use the 1 M Ω setting (but remember that the 1 M Ω input restricts you to a single input range). Also, you may want to use a feedthrough terminator on the output of the test device.

This turns off autoranging. Autoranging must be off during network measurements. Otherwise, the analyzer will try to adjust its input range as the output of the test device changes.

Making Scalar Network Measurements

The Task

5. Press [RANGE].

Then use the knob or numeric keypad to specify an appropriate input range.

6. Press [Source]

[50 OHMS OUTPUT Z]
or
[75 OHMS OUTPUT Z].

7. Toggle to [SOURCE ON OFF].

8. Press [SOURCE AMPLITUDE].

Then use the knob or numeric keypad to specify an appropriate output level.

9. Press [Meas Type].

Then toggle to
[PEAK DET ON OFF].

Select an input range appropriate for your test device. In this example, the 0 dBm range is adequate.

If you've selected the 1 M Ω input impedance, only the 0 dBm range is available.

This selects either a 50 or 75 Ω output for the analyzer's source (tracking generator).

If you select the 75 Ω output impedance, you'll need to connect a 50-to-75 Ω converter (a series 25 Ω resistor) between the analyzer's output and the input of the test device.

If your test device has a different input impedance, use an appropriate impedance converter between the analyzer's output and the input of the test device.

This turns on the analyzer's source.

Select an output level appropriate for your test device. In this example, an output level of 0 dBm is compatible with the test device.

This turns off the analyzer's peak detector. The peak detector, while necessary for most measurements, should not be used for scalar network measurements. Otherwise, a slight frequency skew will be introduced. See the *HP 3588A Operating Manual* to learn more about the peak detector.

10. Press [Avg/Pk Hld]

[VIDEO AVERAGE].

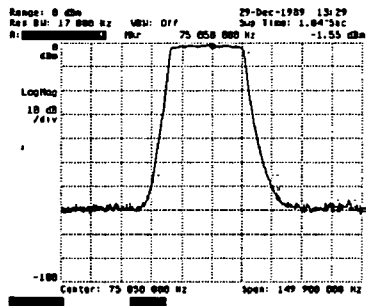

This turns on video averaging. Remember that averaging is exponential, with a weighting factor determined by the number of averages. Unless you've specified otherwise since pressing [Preset], the analyzer uses the default value of 10 averages.

11. Let's examine the shape of the RF filter.

Using the knob, move the marker just to the left of the bandpass response.

Then press [Marker]

[ZERO OFFSET].

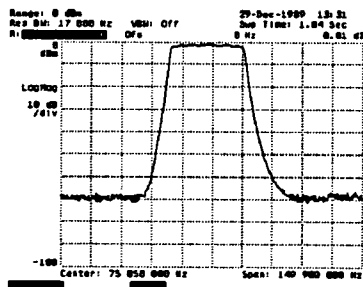

This moves the main marker to the left of the bandpass response, and zeroes the offset marker at this point.

Making Scalar Network Measurements The Task

- Now move the marker just to the right of the bandpass response.

Press

[OFS MKR --> SPAN].

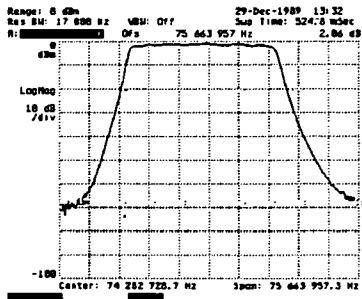

- Press [Scale]

[VERTICAL /DIV].

Then turn the knob until you expand the vertical scale to your liking.

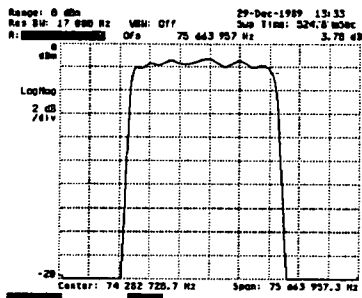

- Press [Marker]

[OFFSET ON OFF].

The offset marker-to-span feature lets you quickly display a frequency span of interest, without specifying start or stop frequencies.

This lets you expand the vertical scale until bandpass ripple is evident.

In the example here, we expanded the scale to 2 dB per division.

This turns off the offset marker.

For most measurements, you'll find yourself pressing [OFFSET ON OFF] often, since this alternates the marker readout between absolute and relative values.

15. Press [Marker]

[MKR --> PEAK].

The marker readout indicates the resonant frequency and insertion loss of the test device.

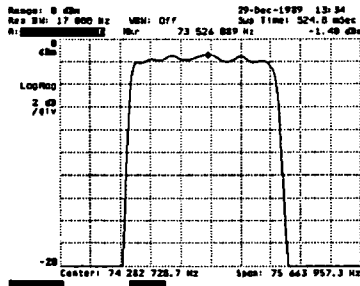

16. Press [OFFSET ON OFF]

[ZERO OFFSET].

17. Turn the knob until the offset marker value shows a -3 dB offset to the *left* of the resonant peak.

Note the frequency value indicated by the offset marker's x-axis position.

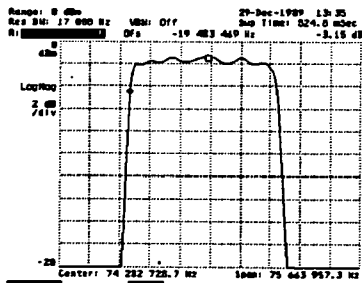

This moves the marker to the peak of the bandpass response.

The marker's x-axis value is the resonant frequency of the bandpass filter. In this example, the resonant frequency is about 73 MHz.

The y-axis position is the insertion loss (or gain) of the filter. The y-axis value is about 1.4 dBm. Since we set the analyzer's source at 0 dBm, the filter has an insertion loss of about 1.4 dB.

This turns on the offset marker again and zeros it at the resonant frequency.

Now you can make measurements relative to the resonant frequency.

In the example shown here, the offset is about 20 MHz.

If you want to know the absolute frequency at this point, press

[OFFSET ON OFF] again to turn off the offset marker. Then press once more to turn it on again.

Making Scalar Network Measurements

The Task

18. Now turn the knob until the offset marker value shows a -3 dB offset to the *right* of the resonant peak.

19. If you have time, complete the next few steps to learn how to normalize your measurement results.

20. Disconnect your test device from the analyzer, and install a barrel connector in its place.

21. Press [**Meas Restart**].

22. Press [**Marker**]

[**OFFSET ON OFF**].

This moves the marker to the 3 dB point to the right of the resonant frequency.

For this example, the offset is about 18 MHz.

Adding the left offset and the right offset of the 3 dB points gives you an approximate 3 dB bandwidth of 40 MHz, centered around 73 MHz.

For maximum accuracy in a scalar network measurement, you should subtract any anomalies introduced by the test fixture—in this case, the two BNC cables you used to connect the RF filter. Normalization also cancels out minor amplitude flatness errors in the analyzer's source.

Normalization is necessary only when you want to measure insertion loss and amplitude flatness of a test device with great precision. For general device characterization, it's not really necessary.

You could normalize the measurement by using the analyzer's trace math capability, but it's much faster if you simply use the [**SAVE NORM REFERENCE**] and [**NORMALIZED SPECTRUM**] softkeys.

In the next few steps, we'll see discover if our insertion loss changes after we normalize the measurement.

The barrel should be a direct connection between both ends, with no other components.

This restarts the measurement, thus making a series of averages without the test device.

This turns off the offset marker.

23. Press [Scale]

[AUTO SCALE].

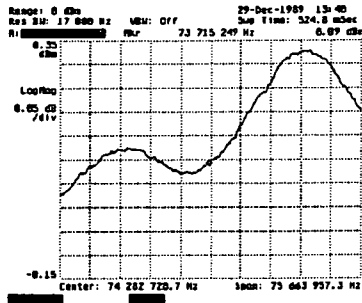

24. Press [Trace Data]

[SAVE NORM REFERENCE].

25. Now remove the barrel connector and reinstall the test device.

26. Press [Meas Restart]

[Scale]

[AUTO SCALE].

27. Press [Trace Data]

[NORMALIZED SPECTRUM].

28. Press [Marker]

[MKR --> PEAK].

Usually, the flatness errors and test fixture anomalies are so small that you'll have to use an expanded scale to see anything.

This automatically stores the current trace (the analyzer's source) into data register D8.

In a moment, you'll repeat the scalar network measurement.

This restarts the measurement and begins a new series of averages.

This is the completed normalized measurement. The analyzer has subtracted test fixture and source amplitude inaccuracies from the trace—producing a better scalar network measurement.

This moves the marker to the peak of the response. In a moment, we'll see how the insertion loss of our test device changes after we normalize the measurement.

Making Scalar Network Measurements

The Task

29. Press [Trace Data].

Now switch between the input spectrum and the normalized results by alternately pressing [INPUT SPECTRUM] and [NORMALIZED SPECTRUM].

30. Press [Scale]

[VERTICAL /DIV].

Then turn the knob until you expand the vertical scale to your liking.

31. Press [Trace Data]

[INPUT SPECTRUM].

32. At this point, you are viewing the input spectrum on Trace A.

Notice how the marker's amplitude reading changes. For our particular device, the normalized trace shows an insertion loss of 1.5 dB—changed from the 1.4 dB of the non-normalized input spectrum.

Of course, your measurement results will be different.

Expanding the analyzer's vertical scale does not increase the accuracy of the insertion loss measurement (the marker readout has the same accuracy regardless of the vertical scale). But it's easier to compare the two traces—as we did in the previous step—if we expand the vertical scale.

In the example here, we expanded the scale to 1 dB per division.

Now we're going to put the non-normalized spectrum on Trace A, and the normalized spectrum on Trace B. This makes it easier to compare the non-normalized results with the normalized results.

The analyzer has two display traces—*Trace A* and *Trace B*. When you first turn on the analyzer, only Trace A is displayed.

You can choose a display format that lets you view one trace at a time, or view both together. If you want to view both traces, you can select the upper/lower format or the front/back format. In the example here, we'll use the upper/lower format.

Notice the indicator *A*: to the left of the trace title (upper left corner of the display). This tells you that the currently active trace is Trace A.

Since Trace A is the default trace, it was selected as the active trace when you turned on the analyzer.

33. Press [Active Trace]
[NORMALIZED SPECTRUM].

34. Press [Scale]
[VERTICAL /DIV].

Using the knob, enter the same vertical scale you used for Trace A.

35. Press [Format]
[UPPER/LOWER].

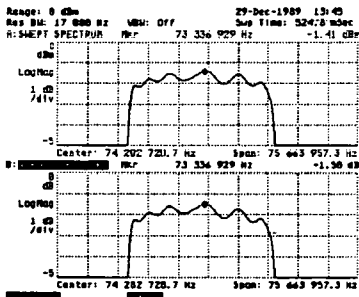

This selects Trace B as the active trace, and assigns the normalized input spectrum to this trace.

In the example here, we expanded the scale to 1 dB per division.

Now you can easily compare both traces.



PART III
Beyond the Basics



Chapter 6

Limit Testing

Limit Testing

Introduction

This chapter provides an overview of limit testing. We've included several sample tasks that show you how to build limits and then use them.

A limit test is a line (or set of lines) that you create to check the performance of a signal source or a device-under-test. When limit testing is on, the analyzer compares a current measurement or a stored trace to the limit you've selected.

A limit appears as a single line (upper or lower limit) or two lines (upper and lower limit). If a trace exceeds the boundaries of these lines, the limit test fails. Limit testing is useful for go/no go checking since a limit test quickly tells you if your device-under-test passes or fails a particular limit test.

You can build a limit line—an upper limit, a lower limit, or set of both upper and lower limits—in several different ways:

- By using the knob (or numeric entry) to arbitrarily construct a limit line.
- By saving a trace, recalling it as a limit, and shifting this newly-created limit up or down to form an upper or lower limit.
- Via HP-IB.

Task 1: Building an Arbitrary Limit

Task Overview

This task shows you how to build an arbitrary limit line. In this example, we're going to test the performance of a simple 20 MHz bandpass filter. However, you can use a filter that has a different passband—the important thing is to understand the measurement task, not to duplicate the measurement results demonstrated here.

What you will need:

- 50 Ω RF Bandpass filter—preferably with adjustable response (in the example, we're using a simple bandpass filter using a 10 μ H inductor, a 2-8 pF variable capacitor, and a 560 Ω resistor).
- 50-to-75 Ω impedance converters (25 Ω series resistors) if your test device has 75 Ω inputs and outputs.
- Feedthrough terminators or impedance converters to match a test device with non-standard input/output impedances.
- Appropriate connecting cables.

What you will do:

- Build an arbitrary limit.
- Compare your test device to this arbitrary limit.
- Change the response of your test device to fail the limit test.

Task Setup

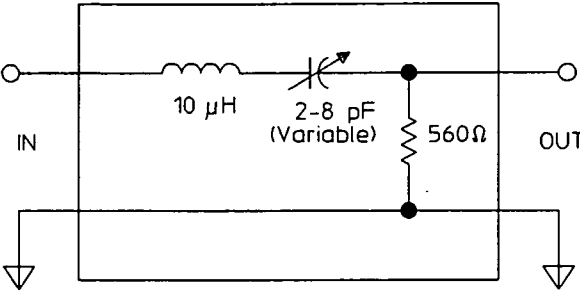

20 MHz Bandpass Filter

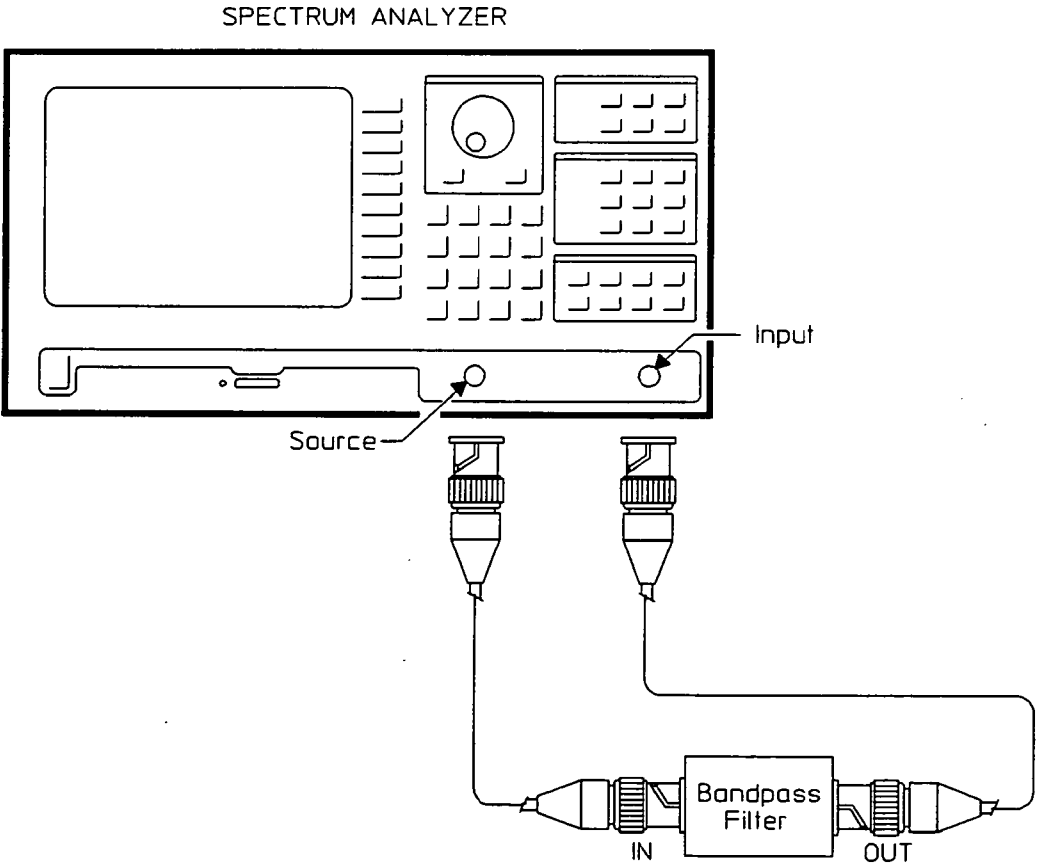

The Task

As you step through the following task, you may find that your measurement results differ slightly from those shown here. Keep in mind that the tasks are designed to help you learn about the analyzer—not to duplicate specific measurement results.

1. Connect a bandpass filter to the analyzer.
2. Make a scalar network measurement, to characterize the response of the bandpass filter.
3. Press [Marker]

[MKR --> PEAK]

[MKR --> CTR FREQ].
4. Press [Scale]

[REFERENCE LEVEL].

Turn the knob to position the trace in the middle of the screen.

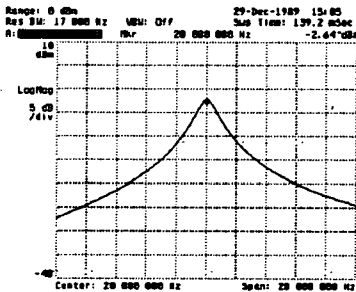

In this example, we used a simple 20 MHz bandpass filter with an adjustable response. Your filter should have an adjustment to vary the bandpass response, though this isn't absolutely necessary.

If you need review, use the procedures outlined in chapter 5.

This moves the peak of the bandpass response to the center of the screen.

It's easier to build an upper limit if you leave some space above the trace.

5. Press [Marker Fctn]

[LIMIT TEST]

[LINES ON].

6. Press [ABSOLUTE LIMIT].

In a moment, you will begin building a limit line.

This tells the analyzer that, for now, the limit you're about to create should be used as an *absolute limit*. You can use specify a limit as either an *absolute* or a *relative* limit. Once you've created a limit, you can use it as an absolute limit or a relative limit, depending on your current measurement situation.

Absolute limits always remain at a fixed amplitude. Use an absolute limit, for example, to make sure a test signal does not exceed a specific amplitude.

Relative limits, on the other hand, are not tied to a specific amplitude. If you make a limit relative, its position on the screen does not change when you change the reference level. You can use a relative limit, for example, to check the relative levels of a test signal's harmonic distortion—or to check the shape (but not the insertion loss) of a filter.

7. Press

[DEFINE UPPER LIM].

You are now ready to start "drawing" the upper limit.

8. Use the knob and the [MOVE MKR HORIZONTAL] and [MOVE MKR VERTICAL] softkeys to move the limit cursor to a convenient starting point.

In the example here, we chose a starting point to the left of the passband response.

9. When you've selected the starting point, press [START SEGMENT].

This anchors the start-point of this segment.

Limit Testing

Task 1: Building an Arbitrary Limit

- Again, use the knob and the [MOVE MKR HORIZONTAL] and [MOVE MKR VERTICAL] softkeys to move the marker cursor to the end point of this first segment.

- Press [FINISH SEGMENT].

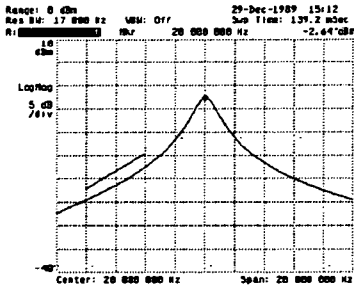

- Now use the knob and the [MOVE MKR HORIZONTAL] and [MOVE MKR VERTICAL] softkeys to move the marker cursor to the end point of the second segment.

Then press [FINISH SEGMENT].

The effect is similar to stretching a rubber band.

This defines the end point of the first limit line segment. The second limit line segment will start where the first one ended.

If you wish, you can leave spaces between a limit line segments. To do this, after pressing [FINISH SEGMENT], move the limit cursor to another location and press [START SEGMENT]. The limit line continues from there.

Broken limit lines are sometimes more convenient—for example, when checking the harmonics of a signal source, or quickly checking bandpass ripple and stopband rejection for a bandpass filter.

But for the example we're using here—checking the response of a bandpass filter—a limit line formed by contiguous line segments is more useful.

Continue this process until you've finished the entire upper limit.

The more line segments you use, the smoother the limit line.

If you make a mistake, simply move the limit cursor to the defective limit segment and press [DELETE SEGMENT]. Then go back and draw the segment again.

13. When you've finished drawing the upper limit, press

[CANCEL/RETURN].

Then toggle to

[TEST EVAL ON OFF].

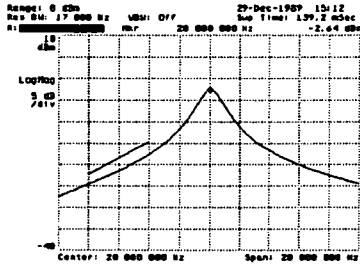

14. Press [Avg/Pk Hld]

[VIDEO AVERAGE]

[OFF].

15. Now vary the response of your bandpass filter until the limit test fails.

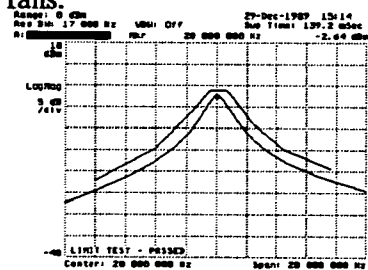

This turns on the limit test evaluation. When test evaluation is on, you can see a message at the bottom of the display that indicates if the device-under-test has passed or failed the limit test.

If the trace remains below the upper limit, the message "LIMIT TEST - PASSED" appears. If the trace exceeds the upper limit, "LIMIT TEST - FAILED" appears.

This ensures that video averaging is turned off.

In the next step, you will change the response of your bandpass filter to cause the limit test to fail. If video averaging is on, it can be difficult to see the effects of this adjustment—unless you specify a small number of averages with the [NUMBER AVERAGES] softkey.

If you can't vary the center frequency of your filter, simply increase the amplitude of the analyzer's source—thereby increasing the output of the filter—until the limit test fails. Press [Source], [SOURCE AMPLITUDE], and use the knob or the numeric keypad to increase the source output.

Alternatively, if your filter is inside a shield can with a detachable cover, you can remove the cover and put your finger near the components. This introduces stray capacitance and may change the bandpass response enough to fail the limit test.

Task 2: Building a Limit from a Trace

Task Overview

This task shows you how to build upper and lower limit lines from a stored trace. In this example, we're going to test the performance of a simple 20 MHz bandpass filter. However, you can use a filter that has a different passband—the important thing is to understand the measurement task, not to duplicate the measurement results demonstrated here.

What you will need:

- 50 Ω RF Bandpass filter—preferably with adjustable response (in the example, we're using a simple bandpass filter using a 10 uH inductor, a 2-8 pF variable capacitor, and a 560 Ω resistor).
- 50-to-75 Ω impedance converters (25 Ω series resistors) if your test device has 75 Ω inputs and outputs.
- Feedthrough terminators or impedance converters to match a test device with non-standard input/output impedances.
- Appropriate connecting cables.

What you will do:

- Save an input trace to a file, and then recall this file to form both an upper and lower limit.
- Move limit lines to form an acceptable limit test.
- Compare your test device to the newly-formed limits.
- Change the response of your test device to fail the limit test.

Task Setup

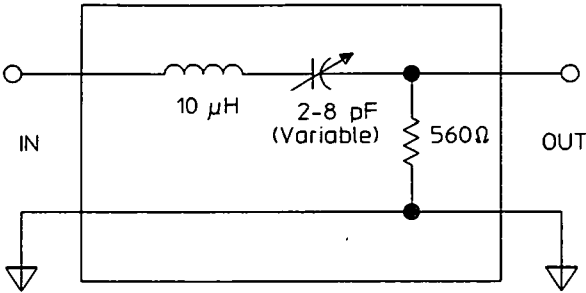

20 MHz Bandpass Filter

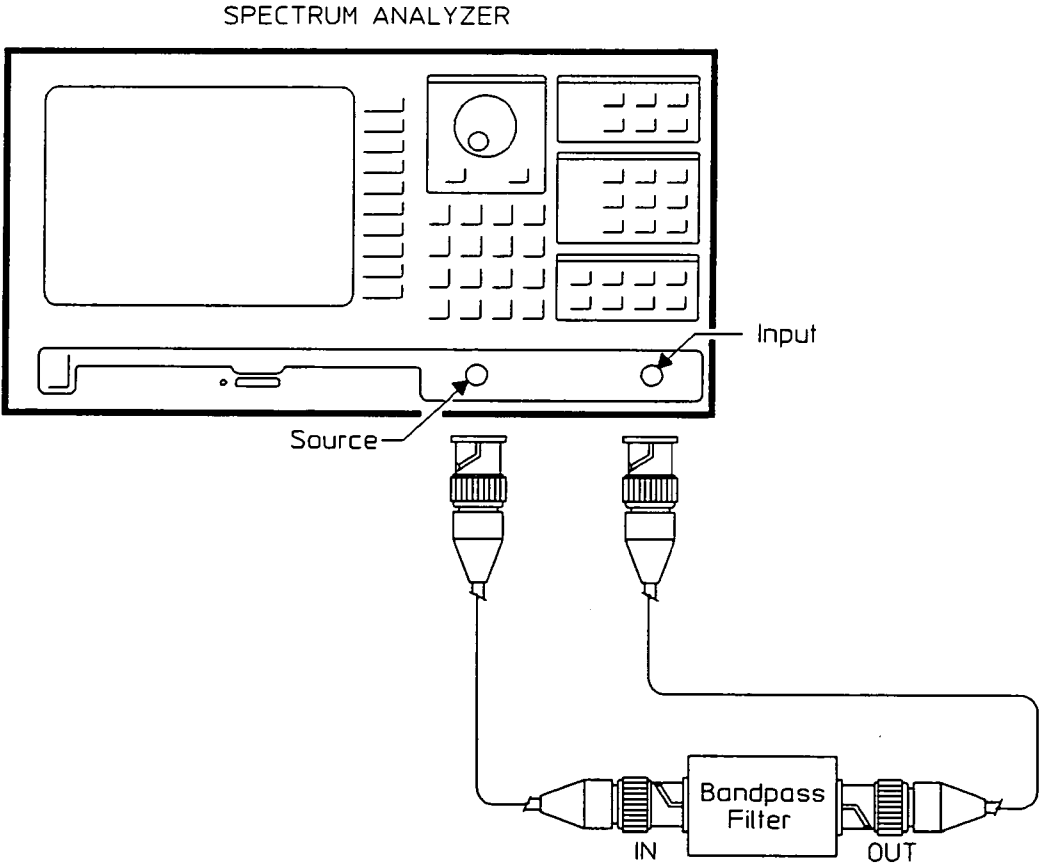

The Task

As you step through the following task, you may find that your measurement results differ slightly from those shown here. Keep in mind that the tasks are designed to help you learn about the analyzer—not to duplicate specific measurement results.

1. Connect a 20 MHz bandpass filter to the analyzer.
2. Make a scalar network measurement, to characterize the response of the bandpass filter.

3. Press [Marker]

[MKR --> PEAK]

[MKR --> CTR FREQ].

4. Press [Scale]

[REFERENCE LEVEL].

Turn the knob to position the trace in the middle of the screen.

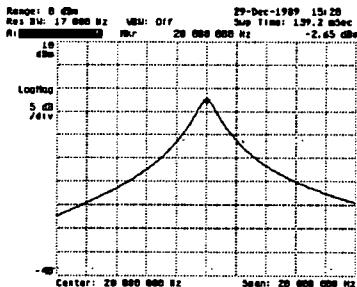

5. Press [Save/Recall]

[DEFAULT DISK]

[VOLATILE RAM DISK].

This is the same 20 MHz bandpass filter we used in the previous example.

If you need review, use the procedures outlined in chapter 5.

This moves the peak of the bandpass response to the center of the screen.

It's easier to build upper and lower limits if you leave some space above and below the trace.

This establishes the analyzer's volatile RAM disk as the current disk.

If you have a formatted 3.5-inch flexible disk, you can press [INTERNAL DISK] instead and use the analyzer's internal disk drive as the disk.

6. Press

[CANCEL/RETURN].

7. Press

[SAVE TRACE]

[INTO FILE].

Then use the knob, the numeric-entry keys, and the alpha-shifted hardkeys to enter a name for the stored trace.

Afterwards, press [ENTER].

8. Press

[CANCEL/RETURN].

Then toggle to
[CATALOG **ON** OFF].

9. If there's more than one file in the volatile RAM, use the knob to highlight the trace file you just saved.

This returns you to the previous menu.

In the example here, we selected "TRACE1" as the name.

When the analyzer prompts you for a name—a filename, for example—it automatically switches to alpha entry mode.

In alpha entry mode, the analyzer shifts certain hardkeys to alpha entry keys (note the alpha characters engraved on the front panel below these hardkeys). You can also specify uppercase or lowercase letters, using the [UPPERCASE LOWERCASE] softkey.

If you make a mistake, you can use the appropriate edit softkeys to fix the name. You can also use the knob to help you edit.

To use the default filename ("TRACE" in this case), simply press [ENTER].

This returns you to the previous menu, and then turns on the catalog for the current disk.

In the example here, there's just one file in the volatile RAM.

The catalog only shows the files stored in the *current* disk. To view files in the other storage devices, you'd have to press [DEFAULT DISK] and make another selection.

Limit Testing
Task 2: Building a Limit from a Trace

10. Press [RECALL MORE]

[RECALL UPPER LIM]

[ENTER].

11. Press [RECALL MORE]

[RECALL LOWER LIM]

[ENTER].

12. Press

[CANCEL/RETURN].

Then toggle to
[CATALOG ON **OFF**].

13. Press [Marker Fctn]

[LIMIT TEST].

Then toggle to
[LINES **ON OFF**].

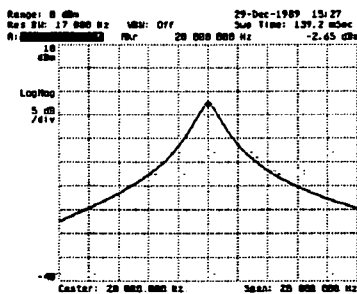

This recalls a trace file as an *upper* limit—in this case, the “TRACE1” file.

This recalls the same trace file as a *lower* limit. a trace file as an upper limit—in this case, the “TRACE1” file.

This returns to the previous menu and turns off the catalog display.

This calls up the limit menu and displays the current limit lines.

The lines for the limits you just recalled are now overlaid directly over the current input trace.

A limit made from a recalled trace is actually made of 400 segments (that’s why it takes longer for the analyzer to draw this type of limit).

14. Press

[DEFINE UPPER LIM]

[MOVE ALL VERTICAL]

and specify 3 dBm with the numeric entry keypad.

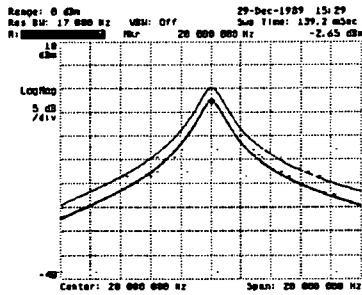

This offsets the upper limit line 3 dBm *above* the current input trace.

15. Press

[CANCEL/RETURN]

[DEFINE LOWER LIM]

[MOVE ALL VERTICAL]

and specify -3 dBm with the numeric entry keypad.

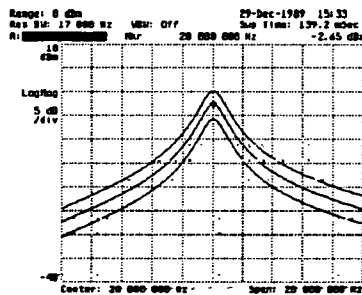

This offsets the lower limit line 3 dBm *below* the current input trace.

Limit Testing
Task 2: Building a Limit from a Trace

16. Press

[CANCEL/RETURN].

Then toggle to

[TEST EVAL ON OFF].

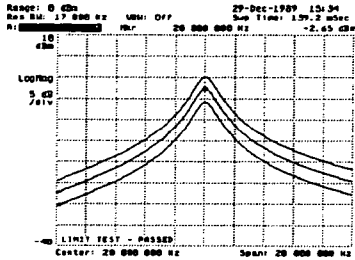

17. Now vary the response of your bandpass filter until the limit test fails.

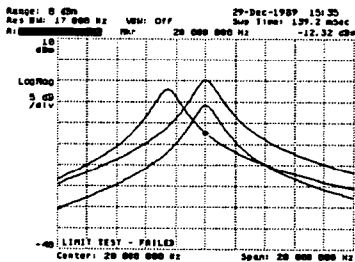

This turns on the limit test evaluation.

You can edit a limit made from a recalled trace the same way you can edit an arbitrary limit. This lets you change the shape of a limit or to remove noise from a limit.

If you can't vary the center frequency of your filter, simply increase the amplitude of the analyzer's source—thereby increasing the output of the filter—until the limit test fails. Press [SOURCE], [SOURCE AMPLITUDE], and use the knob or the numeric keypad to increase the source output.

Alternatively, if your filter is inside a shield can with a detachable cover, you can remove the cover and put your finger near the components. This introduces stray capacitance and may change the bandpass response enough to fail the limit test.



Chapter 7

**Using Keystroke Recording to
Generate an HP Instrument
BASIC Program**

Using Keystroke Recording to Generate an HP Instrument BASIC Program

Introduction

This chapter shows you how to capture a sequence of measurement tasks using the analyzer's *keystroke recording* feature. When keystroke recording is on, the analyzer records your key presses (hardkeys, softkeys, and alpha/numeric entries) and automatically generates an HP Instrument BASIC program that reflects each of these key presses. *This feature is available only if your analyzer is equipped with the HP Instrument BASIC option.*

When you finish a measurement procedure, you can turn off keystroke recording. At this point, you can display the file on the analyzer's screen, edit the program, and then save it to a file on the analyzer's internal disk. Or if you prefer, you can simply save the unedited file to the analyzer's internal disk and move the disk to an external system for editing. To learn more about HP Instrument BASIC, see *Using HP Instrument BASIC with the HP 3588A Spectrum Analyzer*. To learn more about the individual commands used to program the analyzer, see the *HP 3588A HP-IB Programming Reference*.

What is HP Instrument BASIC?

HP Instrument BASIC (a subset of the HP BASIC programming language) is a complete system controller residing inside your analyzer. The HP Instrument BASIC software communicates with the analyzer via HP-IB commands, and can also communicate with other instruments, computers, and peripherals over the HP-IB.

HP Instrument BASIC is available as an option with the HP 3588A Spectrum Analyzer. When installed, you can use it for a wide range of applications—from simple recording and playback of measurement sequences (*keystroke recording*) to sophisticated remote-control operation of other instruments, computers, and peripherals.

This chapter provides only a brief introduction to keystroke recording. It also includes a demonstration of how easy it is to subsequently edit this HP Instrument BASIC program generated by your keystroke sequence. To learn more about HP Instrument BASIC, see *Using HP Instrument BASIC with the HP 3588A Spectrum Analyzer*.

Task Overview

This chapter steps you through a common measurement and shows you how to record the keystrokes of this task using HP Instrument BASIC. *To complete this task, your analyzer must be equipped with the HP Instrument BASIC option.*

What you will need:

- An HP 3588A Spectrum Analyzer *with the HP Instrument BASIC option.*
- One connecting cable, BNC male to BNC male—cable length must be 48 inches (122 cm) or longer if you're using the analyzer's REF OUT for the test signal.
- RF Generator (not required).

What you will do:

- Turn on keystroke recording, make a simple measurement, and then store this measurement sequence as an HP Instrument BASIC program.
- Recall the stored program and edit it.
- Learn about measurement restart procedures and the *WAI command.
- Gain an introduction to both keystroke recording and the HP Instrument BASIC programming language.

Task Setup

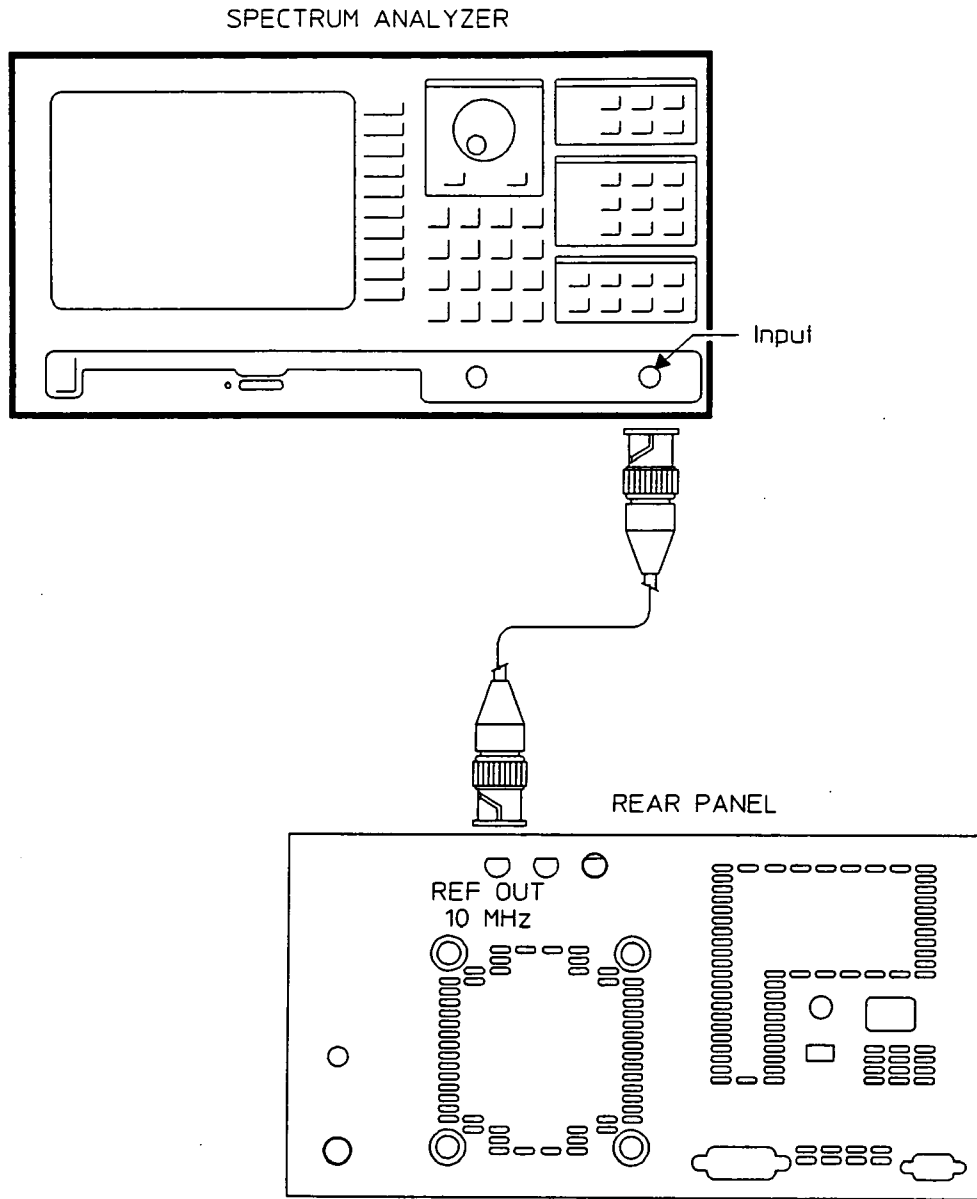

The Task

As you step through the following task, you may find that your measurement results differ slightly from those shown here. Keep in mind that the tasks are designed to help you learn about the analyzer—not to duplicate specific measurement results.

1. If you've already turned on the analyzer, press [**Preset**].

If the analyzer is off, turn it on and wait until it warms up and calibrates. Then press [**Preset**].

2. Connect an RF generator to the analyzer's input.

Use a signal of approximately 10 MHz. The amplitude of the test signal is not important here.

You can also use the 10 MHz REF OUT signal from the analyzer's rear panel.

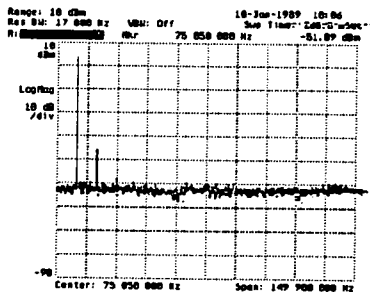

3. Press [**User Define**]

[**UTILITIES**]

[**SCRATCH**]

[**PERFORM SCRATCH**]

[**CANCEL/RETURN**].

Pressing [**Preset**] returns most of the analyzer settings to their default positions.

This task searches for a harmonic, so your test signal should have at least one prominent harmonic.

For this task, it's convenient to use the 10 MHz REF OUT signal from the analyzer's rear panel. This is the same signal we used in chapter 2.

The *scratch* operation erases any previous HP Instrument BASIC program that may have been in the analyzer's program buffer.

When preparing to start a keystroke recorded sequence, it's a good idea to clear the program buffer. Otherwise, your keystroke sequence will be added to the existing program.

4. Press

[ENABLE RECORDING].

This turns on keystroke recording. Anything you do from this point on will be recorded as a set of instructions in the analyzer's program buffer.

Keystroke recording continues until you press [User Define] once more.

5. Press [Preset].

This records a preset operation into the program now being stored.

It's a good idea to press [Preset] before starting *any* measurement procedure. This is especially important for automated procedures, to provide measurements that are both consistent and repeatable.

6. Press [Freq]

[STOP].

This specifies a stop frequency of 25 MHz.

Using the numeric keypad, enter 25 MHz.

7. Press [Avg/Pk Hld]

[VIDEO AVERAGE].

This turns on video averaging.

Although it isn't required for the measurement procedure demonstrated here, averaging slows the measurement sequence somewhat—and this will make it easier for you to watch the recalled program run when it steps through the automated measurement procedure.

8. Press [Meas Restart].

While it may not seem necessary to restart the measurement, pressing [Meas Restart] inserts both a restart procedure (the ABOR and INIT commands) and a wait command (*WAI) into the program now being recorded. Without these commands, the recalled program will not work correctly.

The restart procedure aborts the current measurement and begins a new measurement. The wait command ensures that the analyzer's internal processing is completed before the analyzer actually makes a measurement. Both commands are very important and are frequently used in HP-IB programming.

More specifically, the *WAI command ensures that the analyzer acquires the necessary measurement data before performing subsequent operations. For example, a marker-to-peak command will not find the proper peak if the peak search operation occurs before an entire sweep has completed.

To learn more about *WAI, see the *HP 3588A HP-IB Programming Reference*.

9. Press [Marker]

[MKR --> PEAK]

[ZERO OFFSET]

[NXT RIGHT PEAK].

This moves the marker to the fundamental, turns on the offset marker and zeroes it on the fundamental, and moves the main marker to a prominent harmonic.

10. Press [User Define].

This turns off keystroke recording.

11. Now it's time to test the stored program.

This runs the program you've just created.

Press [RUN].

12. The program should run successfully.

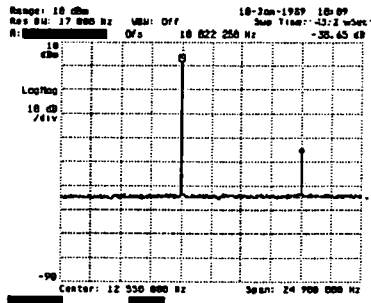

13. Press [Save/Recall]

[DEFAULT DISK]

[VOLATILE RAM DISK].

14. Press

[CANCEL/RETURN].

Here's what you should see (in this order):

- a) a preset operation
- b) the stop frequency change to 25 MHz
- c) video averaging turn on, and restart once
- d) a marker-to-peak operation
- e) the offset marker turn on and zero at the peak
- f) the marker move to the second harmonic

If the program does not run successfully, go back and record it again.

If you want to start over, go back to step 4. *Make sure you scratch (erase) the program buffer as shown in step 4.*

In a moment, you will save the program to a disk.

This establishes the analyzer's volatile RAM disk as the current disk.

If you have a formatted 3.5-inch flexible disk, you can press [INTERNAL DISK] instead and use the analyzer's internal disk drive as the disk.

This returns you to the previous menu.

15. Press [SAVE MORE]

[SAVE PROGRAM].

To use the default program name, simply press [ENTER].

To enter another program name, use the knob, the numeric-entry keys, and the alpha-shifted hardkeys.

Afterwards, press [ENTER].

16. At this point, you don't need to recall the program to run it again. This is because the program is still in the program buffer since you just created it.

In a moment, you will clear the program buffer to practice recalling a program.

17. Press [User Define]

[UTILITIES]

[SCRATCH]

[PERFORM SCRATCH]

[CANCEL/RETURN].

In the example here, we selected "PROG1" as the name.

When the analyzer prompts you for a name—a filename, for example—it automatically switches to alpha entry mode.

In alpha entry mode, the analyzer shifts certain hardkeys to alpha entry keys (note the alpha characters engraved on the front panel below these hardkeys). You can also specify uppercase or lowercase letters, using the [UPPERCASE LOWERCASE] softkey.

If you make a mistake, you can use the appropriate edit softkeys to fix the name. You can also use the knob to help you edit.

Unless the program you want to run is already in the analyzer's program buffer, you must first recall a program. This loads it into the program buffer.

You've just cleared the program buffer.

18. Press [Preset].

In a moment, you will recall the stored program, and edit it.

19. Let's recall the program.

Pressing [Preset] at this point isn't really necessary—we've done it here only to emphasize that you can recall a program after presetting the analyzer. And if we had saved the program to the non-volatile RAM disk or the internal disk, we could recall the program even after cycling the analyzer's power.

Press [Save/Recall]

The default name should be the name of the program you just stored. If it isn't, use the knob, the numeric-entry keys, and the alpha-shifted hardkey to specify the proper name. Then press [ENTER].

[RECALL MORE]

[RECALL PROGRAM]

[ENTER].

20. Press [User Define]

This is the program you just recorded.

[EDIT].

All programs begin with the statement "ASSIGN @Hp3588a TO 800" and terminate with an "END" command.

21. Using the knob, move to line 3.

If you were to run this program from an external system controller, you must change the "800" in the first statement to the current HP-IB address of the HP 3588A analyzer you want controlled. "800" is used only when running this program from the analyzer's internal disk or RAM disks.

Using the knob and the [DELETE CHARACTER] softkey, change the stop frequency from 25 MHz to 55 MHz.

This changes the stop frequency. In a moment, you will run the program again to see how the automated measurement sequence reflects this change.

Then press [ENTER].

Using Keystroke Recording to Generate an HP Instrument BASIC Program

The Task

22. Make sure you've pressed
[ENTER].

23. Press [END EDIT]

[Preset]

[User Define]

[RUN].

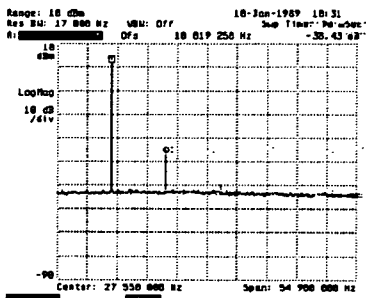

24. If you have time, complete the
remaining part of this task.

25. Press [EDIT]

Using the knob, move the
program cursor to line 5.

26. Press [DELETE LINE]

[ENTER].

The edits you make are not entered into the
program buffer until you press [ENTER].

This runs the program again.

Notice how the stop frequency has changed from
25 MHz to 55 MHz.

Next you will see how removing a *WAI command
affects an automated measurement.

Line 5 should contain the "ABOR; INIT; *WAI"
commands. This is the command line generated
when you pressed [Meas Restart].

The "ABOR" command stops the current
measurement, and the "INIT" command restarts a
new measurement.

This removes the restart commands (ABOR;
INIT) and the *WAI command.

27. Press [END EDIT]

[RUN].

Notice how the marker does not operate properly.

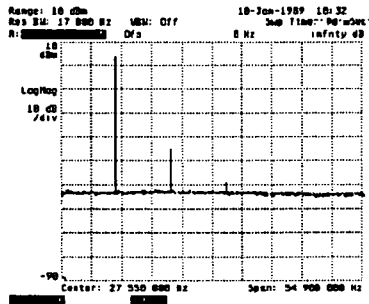

28. Let's see how easy it is to put back these essential commands.

29. Press [EDIT] again.

Using the knob, position the program cursor on line 6.

30. Press [END EDIT]

[ENABLE RECORDING]

[Meas Restart]

[User Define].

This runs the modified program.

The modified program did not include the line generated by pressing [Meas Restart]. Because the modified program lacked both a restart procedure and a *WAI command, the automated measurement did not work properly. Both are needed for this program to run correctly—the restart procedure to make sure there's new data available, and *WAI to make sure the analyzer waits until the entire sweep is finished before performing the marker-to-peak operation.

As we mentioned earlier, subsequent keystroke recording procedures *add* to the program already in the buffer. This lets you insert additional command lines into the program buffer.

When you begin keystroke recording again, the additional command lines will be inserted *on the line above the program cursor*. For this reason, it's important to properly position the program cursor before adding new commands.

This adds the commands generated by pressing [Meas Restart].



Chapter 8

Plotting and Printing Measurement Results

Plotting and Printing Measurement Results

Introduction

This chapter contains two tasks that provide a brief overview of plotting and printing procedures. You can use a variety of HP-IB plotters or printers to show measurement results. Contact your local Hewlett-Packard Sales/Service Office for a listing of currently-supported peripheral devices.

Task 1: Preparing to Plot or Print

1. Connect the plotter/printer to the analyzer's HP-IB connector.

The HP-IB connector is on the analyzer's rear panel.

2. Press [Local/HP-IB]

This sets the analyzer to be the system controller. The analyzer must have control of the HP-IB bus to plot or print anything.

[SYSTEM CONTROLLER]

This procedure assumes that the analyzer is the only controller on the HP-IB. If you have more than one controller, see the *HP 3588A HP-IB Programming Reference*.

3. Determine the HP-IB address of the plotter/printer.

You may need to refer to the operating guide for your particular plotter/printer.

Make sure all external devices on the HP-IB have a unique address.

4. Press

This calls up a menu that lets you select the address of peripheral devices.

[PERIPHERAL ADDRESSES]

5. Press

The address you entered will be retained even if you turn off the analyzer's power.

[PLOTTER ADDRESS]

or

[PRINTER ADDRESS]

Now enter the appropriate address.

Task 2: Plotting or Printing

1. Check to see if the plotter/printer is ready.
2. Press [Plot/Print].

Then press

[PLOT ALL]
or
[PRINT ALL].

3. If necessary, press

[ABORT PLOT/PRINT].

Make sure the plotter/printer is turned on, has paper, and is ON LINE.

Softkey labels do not appear on the plotted or printed results. Also, the analyzer does not send a form-feed command to the printer.

If the "Plot/Print device not present" message appears, you need to:

- Check the connection between the analyzer and the plotter/printer
- Make sure that you have the correct address entered for the plotter/printer
- Make sure there are no other controllers on the HP-IB

This aborts the current plot or print in progress.

When plotting or printing, the analyzer does not respond to any key presses, except [ABORT PLOT/PRINT].



Chapter 9

Saving, Recalling, and Copying Files

Saving, Recalling, and Copying Files

Introduction

This chapter contains several tasks that provide a brief overview of save, recall, and copy operations. Although the sample save and recall operations shown here demonstrate how to save and recall a trace, you can save and recall setup states, limits, and math in the same way.

Overview

The analyzer lets you save (and later recall) the following:

- Traces.
- Instrument setup states.
- Limits.
- Math (current definitions of all five trace math functions and constants).
- HP Instrument BASIC programs.

Selecting a Disk

You can save, recall, or copy to one of three disks:

- The analyzer's internal disk (this accepts standard 3.5-inch flexible disks).
- The analyzer's internal volatile RAM disk (for fast, temporary storage).
- The analyzer's internal non-volatile RAM disk (for fast, permanent storage).

Disk Specifier Prefix and Filenames

Before doing any save or recall operations, make sure you've selected the correct disk. Unless you've used a disk specifier prefix (such as INT: for internal disk), the save/recall operation will use the currently-selected disk.

Here are the disk specifiers:

- NVRAM: for the non-volatile RAM disk.
- RAM: for the volatile RAM disk.
- INT: for the internal disk.

After entering the appropriate disk specifier prefix, you can use the knob, the alpha-shift keys, and the numeric entry keypad to name the file. The filename you use must have no more than ten characters. Also, all characters must be printable.

Note



Files stored in the volatile RAM disk are temporary and will be lost when you turn off the analyzer. Use the analyzer's non-volatile RAM disk or internal disk drive for permanent storage.

Data Registers

In addition to storing on a disk, you can also save an individual trace to one of eight *data registers*. Data registers are provided exclusively for intermediate storage of trace data. Keep in mind that information stored in data registers is volatile, and will be lost when you turn off the analyzer.

When recalling a trace, you simply recall it into a data register and then select this data register for display. This system makes it easy to use trace data as part of a math function.

Typical Save and Recall Tasks

In a few moments you will step through typical save and recall operations, using the analyzer's internal disk drive. After completing these tasks, you can use similar procedures with the analyzer's internal RAM disks.

Before starting the save and recall tasks, you must first designate the analyzer's internal disk as the *default* disk. Afterwards, you will format a blank 3.5-inch flexible disk (if you haven't done so already). Formatting is not required for the analyzer's internal RAM disks, but is allowed.

Task 1: Selecting the Default Disk

1. Press [Save/Recall]

[DEFAULT DISK].

2. Press

[NON-VOL RAM DISK]

or

[VOLATILE RAM DISK]

or

[INTERNAL DISK].

3. Now press

[CANCEL/RETURN].

4. Toggle to [CATALOG **ON** OFF]
to view the contents of the
default disk.

If you are using the internal disk,
you must first insert a formatted
disk into the analyzer's internal
disk drive.

This calls up a menu that lets you designate the
default disk.

The *default* disk is the currently-active disk, and is
therefore the destination for all save and recall
operations—unless you use a different disk
specifier prefix when entering a filename.

The [DEFAULT DISK] softkey is also available from
the [Disk Util] menu.

You can choose either of these disks as the default
disk.

If you choose the internal disk, you'll have to
format a blank disk before you can use it. We'll
show you how in the next task.

This returns you to the previous menu.

The analyzer displays the contents of the disk drive.

To remove the catalog, toggle to
[CATALOG ON **OFF**].

Task 2: Formatting a Blank Disk

1. Make sure the disk you're going to format is *not* write-protected.
2. Insert the disk into the analyzer's internal disk drive.
3. Press [Disk Util]

[FORMAT DISK].
4. For now, ignore the
[FORMAT OPTION] softkey.

The write-protect tab should be covering the square hole at the lower-left hand corner of the flexible disk.

Note the eject button. To avoid damaging the disk, do not eject it when the "busy" light is on.

You are about to format a new disk.

This softkey lets you specify the format option for the disk you are about to format. The default format option 0.

The format option determines the available memory space allocated for the default disk drive. For an internal disk, option 0 allocates 640 kilobytes of memory. For either types of RAM disk, the space allocated is 64 kilobytes.

The format option defines the storage capacity of the disk you are formatting. Format options 0 through 5 are encoded values that give you the following capacities:

Option	RAM	NVRAM	Internal disk
0	64k	63k	640k
1	640k	63k	640k
2	710k	63k	710k
3	788k	63k	788k
4	270k	63k	—
5	640k	63k	64k

Format options 6 through 32 and 767 are only valid for 3.5-inch flexible disks formatted on the internal disk drive. The analyzer interprets values in this range as kilobytes of storage capacity.

5. Also ignore the
[INTRLEAVE FACTOR] softkey.

6. Make sure you really want to
format this disk.

7. Press

[PERFORM FORMAT].

8. When INT: appears at the top of
the screen, press [ENTER].

The interleave factor is the spacing between sectors on a disk. Setting the interleave factor lets you maximize the efficiency of disk operations. Although setting the most efficient interleave factor is not critical for smaller files, it will save lots of time when reading or writing very large files.

The default value is 1. To learn more about the interleave factor, see the HP 3588A Operating Manual.

Formatting a disk destroys any information previously written to the disk. To abort the operation now, press [CANCEL/RETURN].

Pressing [ABORT] after formatting has begun will *not* prevent loss of data.

INT: should appear at the top of the screen (this indicates that the analyzer's internal disk is the default drive).

If RAM: or NVRAM: appears, you haven't selected the internal disk as the default disk—press [CANCEL/RETURN] twice and select the internal disk as the default disk. Or, you can press [CLEAR ENTRY] and enter INT: with the alpha-shifted hardkeys.

This starts the formatting operation.

Task 3: Saving a Trace

This task demonstrates how to save a trace—however, saving a setup state, a limit, or a math function is done the same way.

1. Press [Save/Recall]

[SAVE TRACE].

2. Press

[INTO FILE].

If you have more than one trace displayed, make sure the trace you want to save is the active trace.

The active trace is the one with the highlighted trace label.

You are about to save a trace into a file on the default disk.

The [INTO D1] through [INTO D8] softkeys are used to save traces into a data register.

In addition to storing on a disk, you can also save an individual trace to one of eight *data registers*. Data registers are dedicated spaces in the analyzer's volatile RAM disk, and are provided exclusively for intermediate storage of trace data.

When recalling a trace, you simply recall it into a data register and then select this data register for display. This system makes it easy to use trace data as part of a math function. To learn more about math functions and data registers, see the *HP 3588A Operating Manual*.

Saving, Recalling, and Copying Files
Task 3: Saving a Trace

3. Then use the knob, the numeric-entry keys, and the alpha-shifted hardkeys to enter a name for the stored trace.

Afterwards, press [ENTER].

In the example here, we selected "TRACE1" as the name.

When the analyzer prompts you for a name—a filename, for example—it automatically switches to alpha entry mode.

In alpha entry mode, the analyzer shifts certain hardkeys to alpha entry keys (note the alpha characters engraved on the front panel below these hardkeys). You can also specify uppercase or lowercase letters, using the [UPPERCASE LOWERCASE] softkey.

If you make a mistake, you can use the appropriate edit softkeys to fix the name. You can also use the knob to help you edit.

To use the default filename ("TRACE" in this case), simply press [ENTER].

Task 4: Recalling a Trace

This task demonstrates how to recall a trace—however, recalling a setup state, a limit, or a math function is done the same way.

1. Press [Save/Recall]

[RECALL TRACE].

2. Press

[FROM FILE INTO D1]

Then use the knob, the numeric-entry keys, and the alpha-shifted hardkeys to enter a name for the stored trace.

Afterwards, press [ENTER].

3. Press [Trace Data]

[DATA REG (D1-D8)]

[D1].

You are about to recall a stored trace into a *data register*. You must first load the trace data into a data register before you can view it (or use the trace data in a math function).

This recalls the stored trace into data register D1.

This lets you view the contents of data register D1.

Once you've loaded trace data into a data register, you must select this data register for viewing by pressing [Trace Data].

Task 5: Copying a Disk

This procedure shows how to copy the contents of one 3.5-inch flexible disk to another flexible disk, using the analyzer's RAM disk as intermediate storage. After completing this task, you can use similar procedures to do related operations (for example, copying one of the analyzer's internal RAM disks to the internal disk drive).

1. Press [**Disk Util**]

[**COPY DISK**].

2. Press

[**SOURCE DISK**].

Make sure the INT: specifier prefix appears at the top of the screen—otherwise, the source disk will not be the internal disk.

Using the knob and the alpha-shift keys, specify INT: as the source disk.

When the specifier is correct, press

[**ENTER**].

The copy disk routine will erase all files on the destination disk (the disk you're going to copy to files *to*) before performing the copy operation. Make sure there's nothing important on this disk before you start the copy procedure.

To add files to a disk, copy the files one at a time.

This specifies the source disk as the analyzer's internal disk drive.

The source disk is the disk you're going to copy *from*.

The disk specifier prefix of the default disk appears at the top of the screen.

If the wrong specifier appears, select the specifier appropriate for your source disk:

- *NVRAM*: specifies the non-volatile RAM disk
- *RAM*: specifies the volatile RAM disk
- *INT*: specifies the internal disk drive

Instead of entering the correct disk specifier prefix by using the alpha-shift keys, you can also select the prefix by using the [**DEFAULT DISK**] softkey to change the default disks.

3. Press

[DESTIN DISK].

Using the knob and the alpha-shift keys, specify RAM: as the destination disk.

When the specifier is correct, press

[ENTER].

4. Insert the source disk into the analyzer's internal disk drive.

5. Press

[PERFORM DISK COPY].

6. You've just completed one disk copy operation.

7. Insert the destination disk into the analyzer's internal disk drive.

This specifies the destination disk as the analyzer's internal RAM disk.

The destination disk is the disk you're going to copy *to*.

Because the copy disk routine will erase all files on the destination disk, make sure there's nothing important on the RAM disk before you start the copy procedure.

Make sure the source disk is write-protected, so you don't accidentally erase it.

This disk is write-protected if you can see through the square hole at the lower-left hand corner of the flexible disk.

The copied disk is an image copy, so it will be an exact duplicate of the original disk.

To copy from one 3.5-inch flexible disk to another, you must use the analyzer's RAM disk as intermediate storage. To complete this particular copy procedure, you must now copy from the RAM disk to the *other* 3.5-inch flexible disk.

Make sure the destination disk is *not* write-protected.

This disk is write-protected if you can see through the square hole at the lower-left hand corner of the flexible disk.

Saving, Recalling, and Copying Files
Task 5: Copying a Disk

8. Press

[SOURCE DISK].

Using the knob and the alpha-shift keys, specify RAM: as the source disk.

When the specifier is correct, press

[ENTER].

9. Press

[DESTIN DISK].

Using the knob and the alpha-shift keys, specify INT: as the source disk.

When the specifier is correct, press

[ENTER].

10. Press

[PERFORM DISK COPY].

This specifies the source disk as the RAM disk.

This specifies the destination disk as the analyzer's internal disk drive.

This completes the procedure. You've copied the contents of one 3.5-inch flexible disk to another 3.5-inch disk.

Task 6: Copying a file

This task shows how to copy a trace file from one disk to another. Although the task shown here demonstrates how to copy a trace file from the analyzer's volatile RAM disk to the analyzer's internal 3.5-inch flexible disk, copying from or to the NVRAM disk and internal disk is done the same way. You can also use this procedure to copy individual setup states, limits, or math functions.

1. Press [Save/Recall]

[DEFAULT DISK].

2. Press

[VOLATILE RAM DISK]

3. Now press

[CANCEL/RETURN].

4. Press

[SAVE TRACE].

5. Press

[INTO FILE].

As we mentioned earlier, the *default* disk is the currently-active disk, and is therefore the destination for all save and recall operations—unless you use a different disk specifier prefix when entering a filename.

In this examples, use the analyzer's volatile RAM disk.

This returns you to the previous menu.

If you have more than one trace displayed, make sure the trace you want to save is the active trace.

The active trace is the one with the highlighted trace label.

You are about to save the trace to a file on the volatile RAM disk.

Saving, Recalling, and Copying Files
Task 6: Copying a file

6. Now use the knob, the numeric-entry keys, and the alpha-shifted hardkeys to enter a name for the stored trace.

Afterwards, press [ENTER].

7. Now press

[CANCEL/RETURN].

8. Toggle to [CATALOG **ON** OFF] to view the contents of the default disk.

9. If there is more than one file in the catalog listing, use the knob to highlight the file that you want copied.

10. Press [Disk Util]

[COPY FILE]

[SOURCE FILENAME]

[ENTER].

In the example here, we selected "TRACE1" as the name.

If you make a mistake, you can use the appropriate edit softkeys to fix the name. You can also use the knob to help you edit.

This returns you to the previous menu.

The analyzer will display the contents of the disk drive.

When you have a catalog listing displayed, the analyzer uses the name of the highlighted file as the default file name. This saves you the trouble of entering the name with the alpha shift keys.

Notice how the analyzer used the highlighted file as the source filename.

11. Press

[DESTIN FILENAME].

Then use the knob, the numeric-entry keys, and the alpha-shifted hardkeys to add the disk specifier for the destination disk.

Then press [ENTER].

12. Press [DEFAULT DISK].

Then toggle to [CATALOG **ON** OFF].

In the example here, we kept the original filename but added the "INT:" prefix. The disk specifier prefix is necessary during copy operations since the destination disk is usually not the current default disk.

If you want to copy a file to the same disk—for example, to form a duplicate file on the same disk—you don't need a disk specifier. However, you must use a different destination filename. The analyzer does not allow duplicate filenames.

Don't forget to use a colon between the disk specifier and the filename. Use the appropriate [MORECHARS] softkey to add the colon.

- *NVRAM*: specifies the non-volatile RAM disk
- *RAM*: specifies the volatile RAM disk
- *INT*: specifies the internal disk drive

This lets you view the contents of the internal disk. Notice how the analyzer copied "TRACE1" from the volatile RAM disk to the internal disk.



Index

Index

A

- absolute limits
 - See* limits, absolute
- absolute marker
 - See* marker
- alpha entry mode 2-5
- arbitrary limits
 - See* limits, arbitrary
- automated measurements
 - See* HP Instrument BASIC
- autoranging 4-4
 - during scalar network measurements 5-3
- averaging
 - See* video averaging

C

- center frequency, locating 4-11
- copy operations
 - disk copying 9-10 - 9-12
 - file copying 9-13 - 9-15

D

- data registers 9-2
- default disk 9-4
- disk copying
 - See* copy operations
- disk formatting
 - blank disk 9-5 - 9-6
 - format option 9-5
 - interleave factor 9-6
- disk specifiers 9-2
- display formats 5-10
- display traces 5-10

F

- file copying
 - See* copy operations
- format option
 - See* disk formatting
- formatting, disk
 - See* disk formatting
- frequency counter 2-4
- frequency domain 3-2
- frequency resolution 3-6
- frequency response, measuring 3-7

- frequency span 3-4
 - default 2-3
 - limited 4-9

H

- [Help] 1-5
- hardkeys 1-4
- harmonic distortion, calculating 4-9
- HP Instrument BASIC 7-1

I

- input impedance
 - 1 Megohm 4-3
 - 50 ohm 4-3
 - 75 ohm 4-3
- INT:
 - See* disk specifiers
- interleave factor
 - See* disk formatting

K

- keystroke recording 7-1
- knob, the 1-4

L

- limit testing 6-1 - 6-14
- limited sweep span
 - See* frequency span, limited
- limits
 - absolute 6-5
 - arbitrary 6-2 - 6-7
 - building from stored traces 6-8 - 6-14
 - relative 6-5
- linear amplitude axis 3-3
- local oscillator feedthrough 3-5
- logarithmic amplitude axis 3-3

M

- [Meas Restart], importance of 7-6
- main marker
 - See* marker
- marker 2-4, 4-6
 - See* also offset marker
- measurement speed 3-6

Index (Continued)

N

narrow band zoom measurements 1-1
network measurements

See scalar network measurements

normalization 5-8

numeric entry 1-4

NVRAM:

See disk specifiers

O

offset marker 4-7

offset marker-to-span 5-6

P

peak detector 5-4

peak hold 4-13

plotting 8-1

printing 8-1

program buffer 7-5

R

radio receivers

See spectrum analyzers

RAM:

See disk specifiers

recall operations 9-9

recalling files

See recall operations

reference level 4-6

relative limits

See limits, relative

relative marker

See offset marker

S

save operations 9-7

saving files

See save operations

scalar network measurements 5-1 - 5-11

scratch operation 7-4

softkeys 1-4

toggle 1-4

source amplitude, adjusting 5-4

source impedance

50 ohm 5-4

75 ohm 5-4

source, built-in 1-1, 3-7

spectrum analyzer

basics 3-1

comparison to radio receiver 3-8

swept spectrum measurements 1-1

T

time domain 3-2

trace title 2-5

tracking generator

See source, built-in

V

vertical scaling 4-5

video averaging 2-4, 4-5

Z

zero response

See local oscillator feedthrough

